

NV INDUSTRIAL LIFTING SA



ILSA

MEILI products

Le levage en toute sécurité

Catalogue 11



Kettingen en toebehoren

Kettinglengen - Toebehoren Graad 80 en Graad 100 - Wartels - Oogbouten -
Beweegbare oogbouten - Haken voor wapeningsnetten -
Sluitingen - Din kettingen



Eigenschappen van de ILSALLOY kettingen



De ILSALLOY kettingen voor kettinglengen zijn vervaardigd in STAAL GRAAD 80.

Ze zijn getest en worden geleverd met een fabrieksattest dat de nom.werklast en breuklast opgeeft.

De combinatie van ILSALLOY kettingen en SYSMA toebehoren garandeert de veiligheid op alle niveaus.

Eigenschappen en voordelen van de ILSALLOY kettingen

Gelegeerd niet verouderbaar staal

Fijnkorrelig staal dat noch aan kristalvorming, noch aan veroudering onderhevig werd. Het wordt niet broos en behoudt zijn smeedbaarheid.

Hoge weerstand

De minimale breukweerstand bedraagt 800 N/mm².

Grote oppervlakte hardheid

BRINELL HB 360 hardheid. Deze eigenschap verzekert een hoge weerstand aan wrijving en garandeert een lange levensduur.

Goede elasticiteit

De ILSALLOY kettingen zijn zeer elastisch en bestand tegen schokken ondanks hun grote oppervlakte hardheid. De elasticiteitsgrens wordt in de praktijk steeds overschreden.

Bestand tegen schokken

Bij breuk wordt een verlenging van 17% minimum gegarandeerd. Ook heeft het een perfecte ontbinding. De ILSALLOY ketting is dus uitermate geschikt om er zware werken met veel schokken mee uit te voeren.

Bestand tegen hitte vrieskou

De kettingen en toebehoren behouden hun weerstand tussen de temperaturen van **-40°C** en **+200°C** bij volle last zonder enige vermindering van hun werklast.

TEMPERATUREFFECTEN

Temperatuur	Werklast vermindering (%)	
	In warme toestand	Na afkoeling
- 40 tot 200	0	0
200 tot 300	10	0
300 tot 400	25	0
> 400	Ons raadplegen	

Mechanische eigenschappen

Minimale breukbelasting	- 800 N/mm ² (MPa)
Proefbelasting	- 500 N/mm ² (MPa)
Minimum verlenging bij breuk	-17%
Werklast	- 160 N/mm ²

HOGE LEVENSDUUR - GROTE SLIJTVASTHEID

Industrial Lifting is sinds meer dan 20 jaar de exclusieve belgische verdeeler van de hijstoebehoren van het merk SYSMA, vervaardigd door FORGE FRANCE.

De smederij, gelegen in het noorden van Frankrijk, is wereldwijd bekend voor de kwaliteit van haar producten. U zal haar volledig gamma hijstoebehoren in graad 80 en 100 vinden in de volgende paginas van deze catalogus.

Alle producten FORGE FRANCE zijn voorzien van het teken H98 dat gegeven wordt door het befaamd Duits keuringsorganisme BG (Berufsgenossenschaft). De houder van zo'n teken wordt jaarlijks onderworpen aan controleaudits om na te gaan of zijn producten aan de Europese normen EN 818 en EN 1677 beantwoorden.

Wij bezitten een horizontale trekbank van 25 ton waarmee we testen kunnen uitvoeren.



Eigenschappen van GRAAD 100

De **SYSMAX** toebehoren zijn gemaakt uit speciaal staal eigen aan Forge de France. Zij garandeert een uniforme verdeling van de effecten van de thermische behandeling in het stuk (homogeniteit van de staalstructuur), hoge mechanische eigenschappen (hoge ductiliteit) en een uitstekende uithouding in de tijd.

Dankzij de combinatie van grondstoffen van zeer hoge kwaliteit met een uiterst nauwkeurige thermische behandeling heeft Forge de France een nieuw gamma kettingtoebehoren kunnen ontwikkelen die een 25% hogere SWL vertoont dan die in gr.80 terwijl het de afmetingen van het gamma gr.80 behoudt!.

De lichtere SYSMAX kettinglengen zijn gemakkelijker behandelbaar. Vb. een kettingviersprong gr.100 om een gewicht van 10t te heffen ($40^\circ < B < 60^\circ$) zal 28% lichter zijn dan dezelfde kettingviersprong in gr.80!

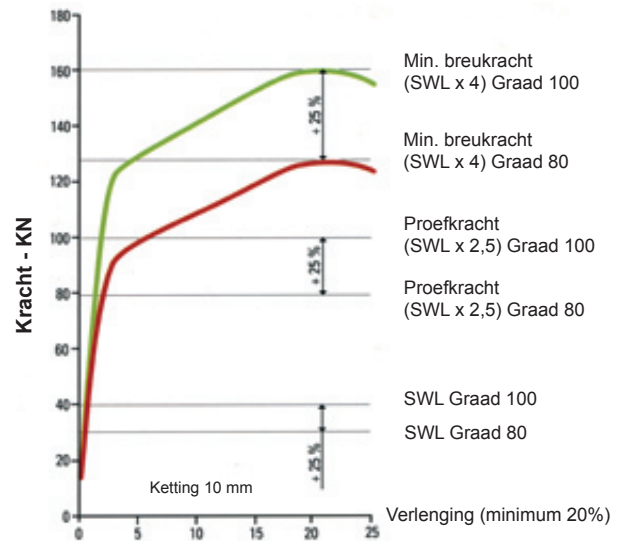

De SYSMAX toebehoren genieten een speciale thermische behandeling op een temperatuur van 400°C.

Compatibiliteit met het gamma gr.80: de toebehoren gr.100 kunnen desnoods gebruikt worden om een kettingleng gr.80 te herstellen. (deze leng behoudt dan natuurlijk haar eigenschappen gr.80).

De afmetingen van de toebehoren blijven dezelfde, zowel gr.80 als gr.100.

Toebehoren van de kettingleng (om 10 ton op te tillen)	Gewicht in kg in graad 80	Gewicht in kg in graad 100
Haak CLC (4)	23	12,4
Omega schalm (4)	4,6	2,4
Ketting (4X2m)	43,2	29
Driedubbele ring	5,9	11
Totaal gewicht (kg)	76,7	54,8

SAMENSTELLING VAN KETTINGLENGEN IN ONZE WERHUIZEN DOOR GEKWALIFICEERD PERSONEEL



Tabel van de aangepaste maximale werklasten der kettinglengen naargelang de gevormde hoek aan de top

Diam. ketting		1 eind	Zonder eind	2 einden			3 & 4 einden			Glijk-noop	Enke op 2 einden			
(mm)		(t)	(t)	(t)			(t)			(t)	(t)			
				a			2 Y of a					a		
				0 tot 60°	60° tot 90°	90 tot 120°	0 tot 60°	60° tot 90°	90 tot 120°			0 tot 60°	60° tot 90°	90 tot 120°
6	Graad 80	1,1	2	1,9	1,6	1,1	2,9	2,4	1,7	0,8	1,7	1,4	1	
	Graad 100	1,4	2,5	2,4	2	1,4	3,6	3,0	2,1	1	2,1	1,8	1,3	
7	Graad 80	1,5	2,7	2,6	2,1	1,5	3,9	3,2	2,2	1,2	2,5	2,1	1,5	
	Graad 100	1,9	3,4	3,3	2,7	1,9	4,9	3,9	2,8	1,5	3,1	2,6	1,9	
8	Graad 80	2	3,6	3,5	2,8	2	5,2	4,3	3	1,6	3,4	2,8	2	
	Graad 100	2,5	4,5	4,3	3,5	2,5	6,5	5,3	3,8	2	4,3	3,5	2,5	
10	Graad 80	3,2	5,6	5,5	4,3	3,2	8,2	6,7	4,8	2,5	5,5	4,4	3,2	
	Graad 100	4	7	6,8	5,3	3,9	10,3	8,4	5,9	3,1	6,9	5,5	3,9	
13	Graad 80	5,3	9,5	9,2	7,5	5,3	13,8	11,2	8	4,2	9	7,4	5,3	
	Graad 100	6,7	11,9	11,5	9,4	6,6	17,3	14	10	5,3	11,3	9,3	6,6	
16	Graad 80	8	14,4	13,8	11,2	8	20,8	17	11,8	6,4	13,6	11,2	8	
	Graad 100	10	18	17,3	14	10	26	21,3	14,8	8	17	14	10	
20	Graad 80	12,5	22,5	21,6	17	12,5	32,5	26,5	19	10	21,2	17,5	12,5	
	Graad 100	16	28,1	27	21,3	15,6	40,6	33,1	23,8	12,5	26,5	21,9	15,6	
22	Graad 80	15	27	26	21,2	15	39	31,5	22,4	12	25,5	21	15	
	Graad 100	18,8	33,8	32,5	26,5	18,8	48,8	39,4	28	15	31,9	26,3	18,8	
26	Graad 80	21,6	58,8	36,7	30	21,2	55	45	31,5	17,2	36,7	30,2	21,2	
	Graad 100	26,5	73,5	45,9	37,5	26,5	68,8	56,3	39,4	21,5	45,9	37,8	26,5	
32	Graad 80	31,5	56,7	54,5	45	31,5	82	67	47,5	25,2	53,5	44	31,5	
	Graad 100	40	70,9	68,1	56,3	39,4	102,5	83,8	59,4	31,5	66,9	55	39,4	

Markeerster N°3



De markeerster beantwoordt precies aan de eisen van de EEG richtlijnen 89/392/EEG en 91/368/EEG met betrekking tot het identificeren van de lengen.

- a :** Geeft de gebruikte hoek tussen de parten aan.
- Einden :** Geeft het aantal parten aan van de kettingleng.
- SWL:** Geeft de nom.werklast aan in ton.
- LG:** Geeft de totale lengte aan . binnenkant ring tot binnenkant haak.
- Frabrikatie jaar van de leng**

Onze markeersterren zijn vervaardigd in VERZINKT staal.

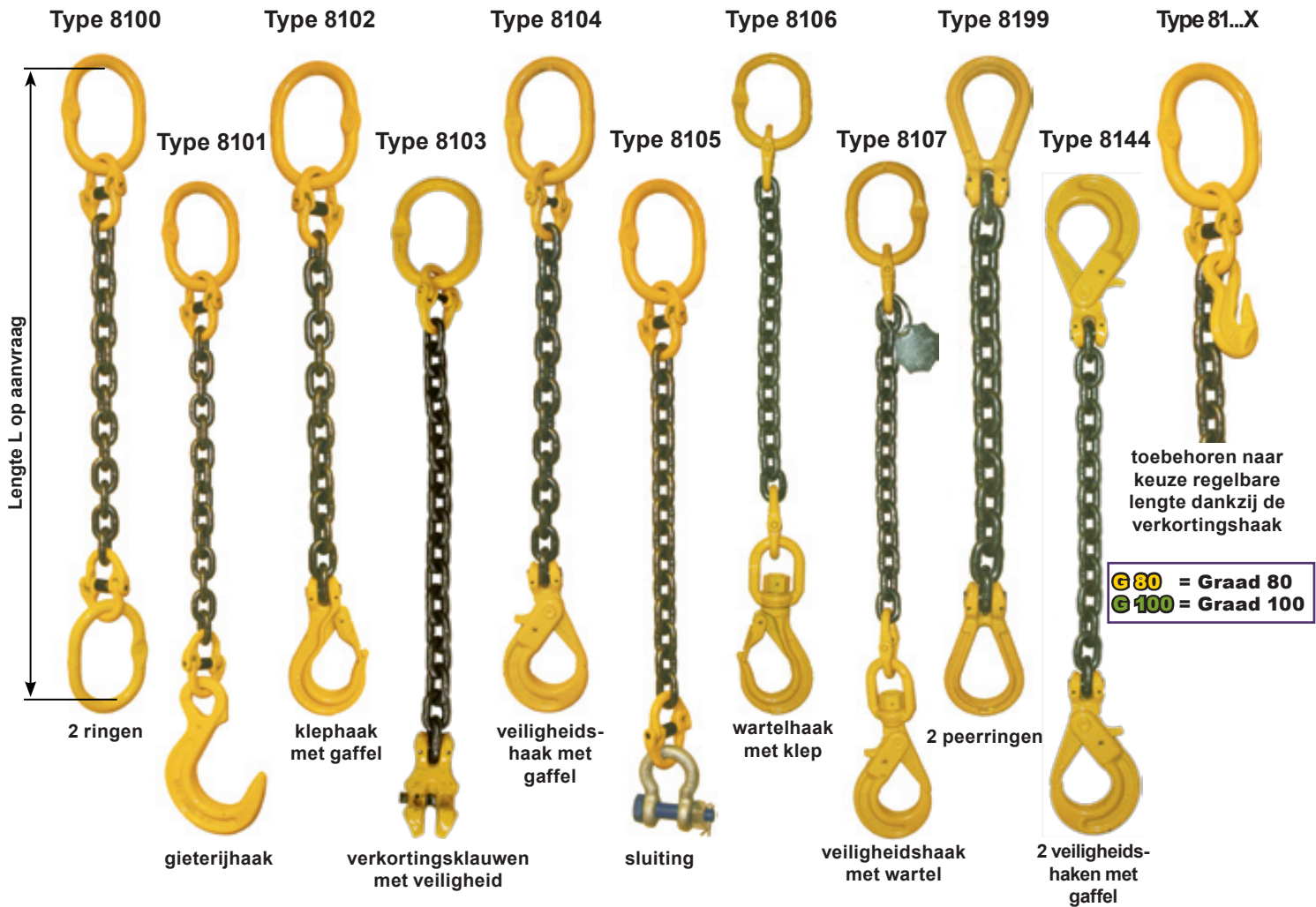

Markeerster N°3 in verzinkt staal

Zie blz. 50

De vervaardiging van onze kettinglengen gr.80 zijn conform met de norm EN818-4. Ze zijn zo samengesteld dat een onvrijwillige loskoppeling van een element onmogelijk is. De toebehoren moeten een SWL hebben die minstens gelijk is aan die van de ketting.

Aan elke leng wordt een metalen markeerster bevestigd aan de bovenring op de welke het volgende staat: de SWL in ton, de klasse van het staal (vb. gr80), de naam van de samensteller van de kettingleng, het aantal parten, het nummer van deze leng alsook het jaartal waarin zij werd samengesteld.

Elke leng wordt vergezeld van een CE-attest die bevestigt dat zij werd samengesteld in overeenstemming met de Europese Machinerichtlijn 98/37/EEG.

Type ABCD

- 1^{ste} nummer :** 8 : Type kettingleng (7 = Meccano leng zie blz 188-189).
- 2^{de} nummer :** Aantal strengen.
- 3^{de} nummer :** Type bovenste accessoire
 bv. : 0 : ring 1 : gieterijhaak 2 : klephaak met gaffel
- 4^{de} nummer :** Type onderste accessoire
 bv. : 3 : verkortingsklauw met veiligheid 4 : veiligheidshaak met gaffel.

Standaard zijn onze kettinglengen uit **Graad 80** staal gemaakt. Indien u dit wenst worden ze vervaardigd uit **Graad 100** staal; vergeet het dan niet uitdrukkelijk te vragen.

Diam. ketting (mm)	G 80			G 100			
	SWL (kg)	Bovenste ring	Afmetingen ring (mm)	Diam. ketting (mm)	SWL (kg)	Bovenste ring	Afmetingen ring (mm)
6	1120	A301	100 x 60	6	1400		
7	1500	A301	100 x 60	7	1900	A302X	110 x 70
8	2000	A302	120 x 175	8	2500	A302X	110 x 70
10	3150	A303	135 x 75	10	4000	A303X	135 x 75
13	5300	A304	150 x 90	13	6700	A306X	195 x 106
16	8000	A305	150 x 90	16	10000	A306X	195 x 106
20	12500	A307	200 x 120	20	16000		
22	15000	A307	200 x 150	22	19000		
26	21600	A308	200 x 150	26	27000		
32	31500	A309	280 x 170				

De technische fiches van alle toebehoren vindt u op de volgende pagina's.

Voor uw veiligheid, gelieve de gebruiksinstructies i.v.m. de kettinglengen op blz. 332 te raadplegen

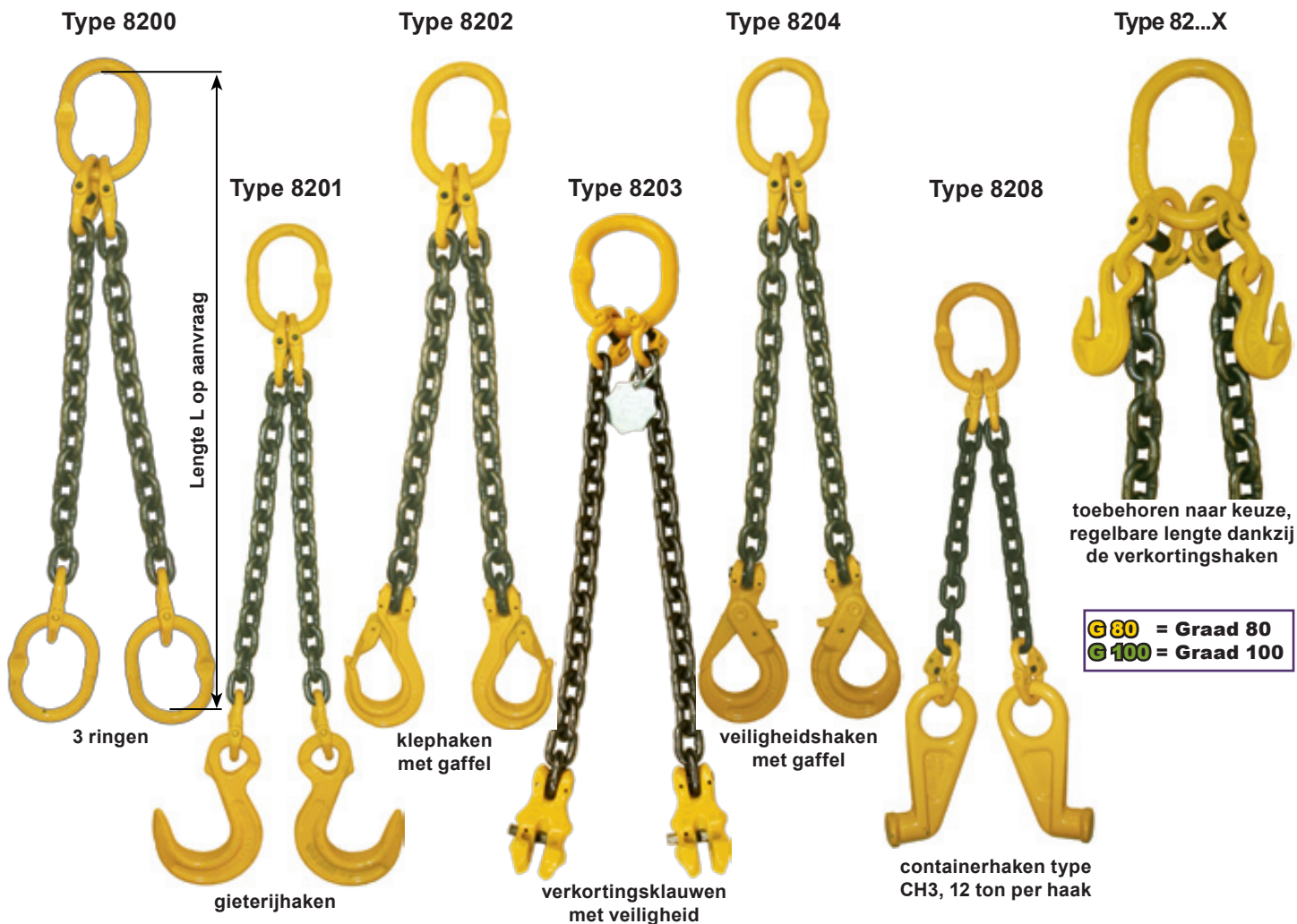

Markeerster N°3 in verzinkt staal

Zie blz. 50

De vervaardiging van onze kettinglengen gr.80 zijn conform met de norm EN818-4.

Ze zijn zo samengesteld dat een onvrijwillige loskoppeling van een element onmogelijk is.

De toebehoren moeten een SWL hebben die minstens gelijk is aan die van de ketting.

Aan elke leng wordt een metalen markeerster bevestigd aan de bovenring op de welke het volgende staat: de SWL in ton, de klasse van het staal (vb. gr80), de naam van de samensteller van de kettingleng, het aantal parten ,het nummer van deze leng alsook het jaartal waarin zij werd samengesteld.

Elke leng wordt vergezeld van een CE-attest die bevestigt dat zij werd samengesteld in overeenstemming met de Europese Machinerichtlijn 98/37/EEG.

G 80						G 100					
Diam. ketting (mm)	SWL (kg)			Bovenste ring	Afmetingen ring (mm)	Diam. ketting (mm)	SWL (kg)			Bovenste ring	Afmetingen ring (mm)
	Nominaal	0° tot 90°	90° tot 120°				Nominaal	0° tot 90°	90° tot 120°		
6	2240	1600	1120	A302	120 X 75	6	2400	2000	1400		
7	3000	2120	1500	A302	120 X 75	7	3800	2650	1900	A302X	110 x 70
8	4000	2800	2000	A303	135 X 75	8	5000	3550	2500	A303X	135 x 75
10	6300	4250	3150	A305	150 X 90	10	8000	5600	4000	A304X	150 x 90
13	10600	7500	5300	A306B	200 X 120	13	13400	9500	6700	A306X	195 x 106
16	16000	11200	8000	A307	200 X 120	16	20000	14000	10000	A307X	235 x 126
20	25000	17000	12500	A308	250 X 150	20	28000	20000	14000	A307BX	270 x 150
22	30000	21200	15000	A309	280 X 170	22	32000	22400	16000	A309X	340 x 180
26	42000	30000	21200	B1A40T	300 X 200	26	54000	37800	27000		
32	63000	45000	31500	B1A50T	350 X 200						

De technische fiches van alle toebehoren vindt u op de volgende pagina's.

Voor uw veiligheid, gelieve de gebruiksinstructies i.v.m. de kettinglengen op blz. 332 te raadplegen

Kettinglengen 3 en 4 einden

GRAAD 80 en GRAAD 100

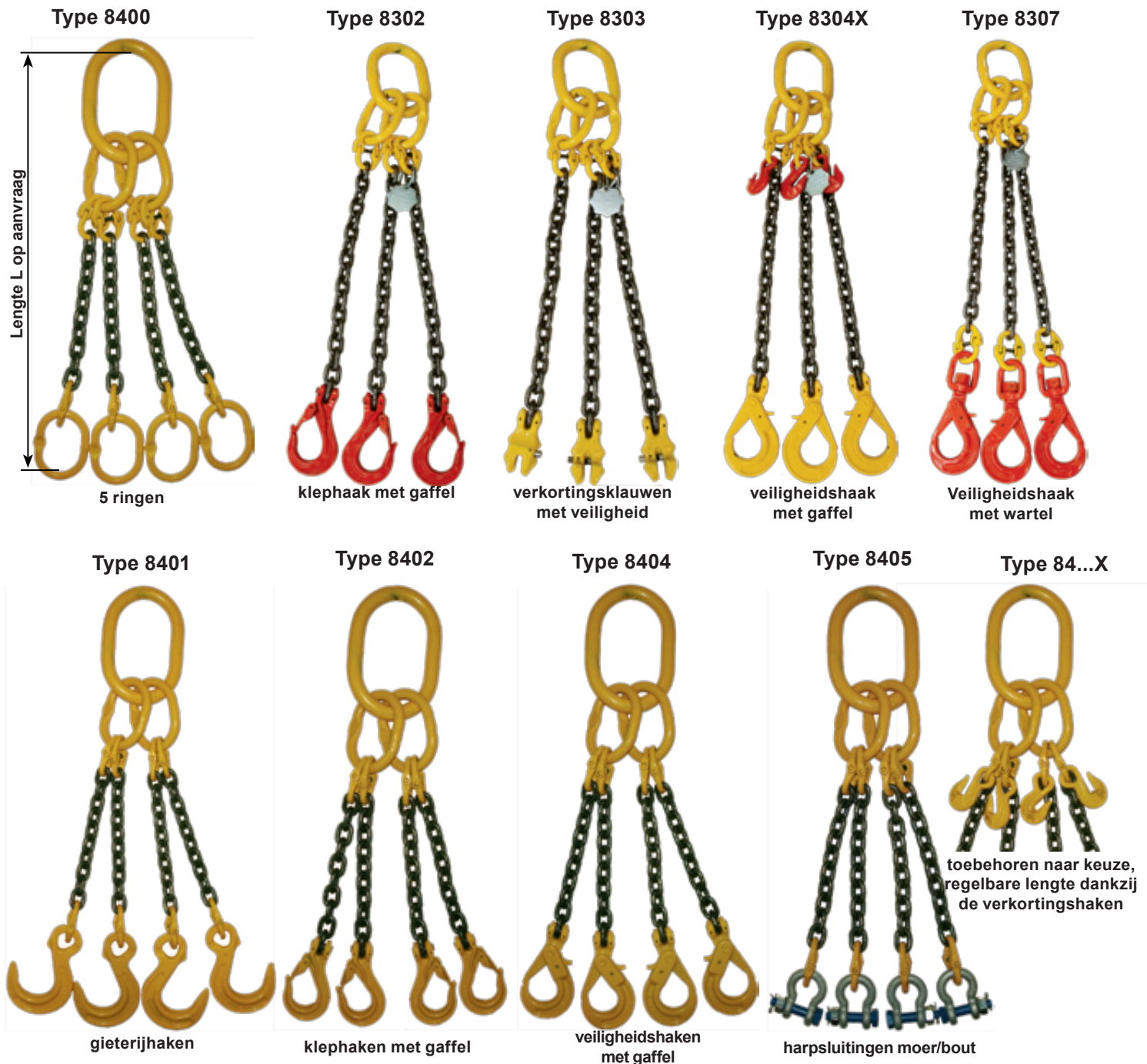

G 80

Diam. ketting (mm)	SWL (kg)			Bovenste ring	Afmetingen ring (mm)
	Nominaal 4 einden	0° tot 90°*	90° tot 120°*		
6	4480	2360	1700	A312	130 x 75
7	6000	3150	2240	A313	150 x 90
8	8000	4250	3000	A314	170 x 95
10	12 600	6700	4750	A315	200 x 125
13	21200	11200	8000	A317	250 x 150
16	32000	17000	11800	A318	280 x 170
20	50000	26500	19000	A319	300 x 200
22	60000	31500	22400	A320	300 x 200
26	84000	44500	31500	A322	400 x 250
32	126000	67000	47500	A323	400 x 250

G 100

Diam. ketting (mm)	SWL (kg)			Bovenste ring	Afmetingen ring (mm)
	Nominaal 4 einden	0° tot 90°*	90° tot 120°*		
6	5600	3000	2120		
7	7600	4000	2800	A312BX	135 x 75
8	10000	5300	3750	A312BX	135 x 75
10	16000	8500	6000	A314X	150 x 90
13	26800	14000	10000	A317X	200 x 120
16	40000	21200	15000	A317CX	235 x 120
20	64000	34000	24000	A318X	270 x 150
22	76000	39900	28500	A319X	300 x 160
26	108000	56700	40500		

De technische fiches van alle toebehoren vindt u op de volgende pagina's.
 * zelfde SWL voor kettingen met 3 en 4 einden.

Voor uw veiligheid, gelieve de gebruiksinstructies i.v.m. de kettinglengen op blz. 332 te raadplegen

Hijsketting volgens EN 818 type A1

GRAAD 80

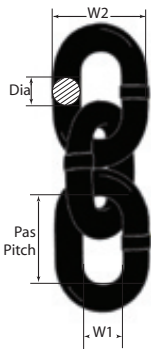

Ref.	Diam. (mm)	SWL (t)	Pas (mm)	W1 (mm)	Gewicht (kg/m)	Code art.
A 101	6	1,12	18	8,5	0,75	
A 102	7	1,5	21	10,5	1,1	
A 103	8	2	24	11,5	1,4	
A 104	10	3,15	30	13,5	2,2	
A 105	13	5,4	39	19	3,6	
A 106	16	8	48	22,5	5,4	
A 107	20	12,5	60	30	8,5	
A 108	22	15	66	30,5	10,4	
A 109	26	21	78	36,5	15	
A 110	32	31,5	96	41	22	

Veiligheidshaak met gaffel type A6

GRAAD 80

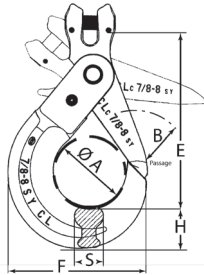

Ref.	Diam. (mm)	SWL (t)	A (mm)	B (mm)	E (mm)	F (mm)	H (mm)	S (mm)	Gewicht (kg)	Coder art.
A 600	6	1,12	34	30	88	75	24	15	0,5	
A 601	7/8	2	45	38	111	88	27	18	0,75	
A 602	10	3,15	55	44	142	108	33	25	1,5	
A 603	13	5,3	68	50	175	138	44	34	3,1	
A 604	16	8	88	66	214	171	47	35	5,9	
A 605	18/20	12,5	100	80	239	197	55	52	8,4	
A 606	22	15	113	95	281	225	64	53	12,5	
A 607	24/26	21,2	125	87	319	253	78	52	22,5	

Compacte veiligheidshaak met gaffel type DKC

GRAAD 80

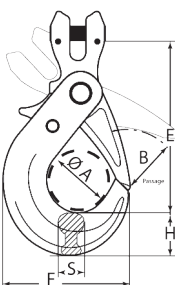

Ref.	Diam. (mm)	SWL (t)	A (mm)	B (mm)	E (mm)	F (mm)	H (mm)	S (mm)	Gewicht (kg)	Code art.
DKC 1	7/8	2	34,8	33,5	95	75,5	26,5	17,5	0,46	
DKC 2	10	3,15	45,3	42	117	89,5	30	25	0,87	
DKC 3	13	5,3	54,5	48	145	108	36	32,8	1,7	
DKC 4	16	8	70,5	58	178	139	47	38,5	3,8	

Veiligheidshaak met oog type B5

GRAAD 80

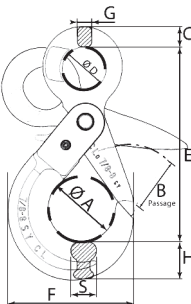

Ref.	Diam. (mm)	SWL (t)	A (mm)	B (mm)	C (mm)	D (mm)	E (mm)	F (mm)	G (mm)	H (mm)	S (mm)	Gewicht (kg)	Code art.
B 506	5/6	1,12	34	30	10	22	110	75	10	24	15	0,5	
B 507	7/8	2	46	38	14	30	134	87	11	26	18	0,8	
B 508	10	3,15	56	44	15	36	167	107	13	33	25	1,55	
B 509	13	5,3	72	51	21	47	200	137	17	42	34	3,15	
B 510/1	16	8	88	66	27	60	253	171	20	47	35	6,05	
B 511	18/20	12,5	100	80	27	64	274	197	21	55	52	7,6	
B 512	22	15	113	95	35	71	314	225	26	64	53	12,6	
B 513	24/26	21,2	125	87	40	80	371	253	33	78	52	23	

Compacte veiligheidshaak met oog type DK

GRAAD 80

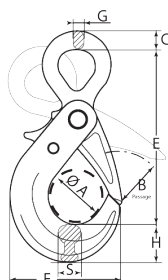

Ref.	Diam. (mm)	SWL (t)	A (mm)	B (mm)	C (mm)	D (mm)	E (mm)	F (mm)	G (mm)	H (mm)	S (mm)	Gewicht (kg)	Code art.
DKO 1	7/8	2	34,38	33,5	12	23	113	75,5	8,5	26,5	17,5	0,48	
DKO 2	10	3,15	45,3	42	15	28,5	138	89,5	10,5	30	25	0,83	
DKO 3	13	5,3	54,5	48	19	37	173	108	11,5	36	32,8	1,67	
DKO 4	16	8	70,5	58	25	54	226	139	16,5	47	38,5	3,4	

Veiligheidshaak met wartel type B6

GRAAD 80

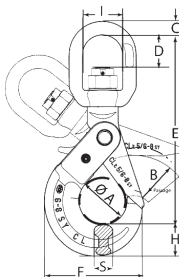

Ref.	Diam. (mm)	SWL (t)	A (mm)	B (mm)	C (mm)	D (mm)	E (mm)	F (mm)	G (mm)	H (mm)	S (mm)	Gewicht (kg)	Code art.
B 606	5/6	1,12	34	30	10	25	144	75	11	24	15	0,6	
B 607	7/8	2	45	38	12	30	178	88	12	27	18	1	
B 608	10	3,15	55	44	14	35	208	108	14	33	25	2	
B 609	13	5,3	68	50	18	45	252	138	16	44	34	3,8	
B 610	16	8	85	66	20	60	322	175	20	46	35	7	
B 611	18/20	12,5	100	80	28	60	360	190	26	52	40	9,6	
B 612	22	15	125	87	33	77	420	254	34	78	53	16,25	

Gaffelhaak met klep type A5/CLL

GRAAD 80

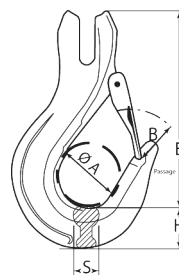

Ref.	Diam. (mm)	SWL (t)	A (mm)	B (mm)	E (mm)	H (mm)	S (mm)	Gewicht (kg)	Code art.
A 501	5/6	1,12	34	18	74	19	15	0,28	
CCL 8	7/8	2	39	29	99	25	20	0,62	
CCL 10	10	3,15	45	33	120	27	26	1,11	
CCL 13	13	5,3	51	42	136	35	30	1,88	
A 505	16	8	68	48	168	46	36	3,8	
A 506	18/20	12,5	78	54	195	51	50	6,2	

Ooghaak met klep type B2/COL

GRAAD 80

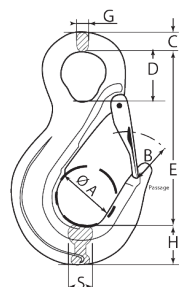

Ref.	Diam. (mm)	SWL (t)	A (mm)	B (mm)	C (mm)	D (mm)	E (mm)	G (mm)	H (mm)	S (mm)	Gewicht (kg)	Code art.
B 202	5/6	1,12	34	22	10	20	86	9	18	15	0,27	
COL 8	7/8	2	40	28	11,5	27,5	111	11	23	20,5	0,68	
COL 10	10	3,15	46	33	14	33	130	13,5	27	26	1,15	
COL 13	13	5,3	52	41	18	44	151	16,5	36	30	1,8	
B 210	16	8	68	48	22	54	182	19	44	34	3	
B 212	18/20	12,5	78	50	26	52	218	24	50	50	6	

Wartelhaak met klep type B4/CEL

GRAAD 80

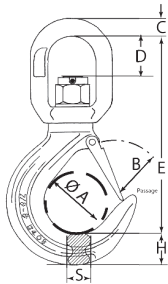

Ref.	Diam. (mm)	SWL (t)	A (mm)	B (mm)	C (mm)	D (mm)	E (mm)	H (mm)	S (mm)	Gewicht (kg)	Code art.
B 4105	6	0,5	33	21	10	28	124	21	16	0,5	
B 406	5/6	1,12	34	18	11	28	120	19	15	0,4	
CEL 8	7/8	2	40	30	12	30	156	22	20	0,8	
CEL 10	10	3,15	45	34	14	36	187	27	27	1,4	
CEL 13	13	5,3	51	43	18	42	222	36	31	2,6	
B 416	16	8	68	46	20	55	277	44	36	4,4	
B 420	18/20	12,5	66	51	25	86	319	61	46	9,5	

Verkortingshaak met oog type A71

GRAAD 80

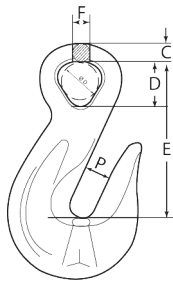

Ref.	Diam. (mm)	SWL (t)	C (mm)	D (mm)	E (mm)	F (mm)	P (mm)	Gewicht (kg)	Code art.
A 711	5/6	0,9	8	10	42	8	7	0,12	
A 712	7/8	1,6	10	12	57	8	9	0,21	
A 713	10	2,5	10,5	14	70	10	12	0,4	
A 714	13	4,25	13	22	91	13	15	0,86	
A 715	16	6,4	19	30	115	17	20	1,6	
A 716	18/20	10	21	35	133	21	23	3	
A 717	22	15		44	122	26,5	25	4,72	
A 718	26	21		48	146	32	30	9,5	
A 719	32	32		54	197	40	38	18,8	

Verkortingshaak met gaffel type A70

GRAAD 80

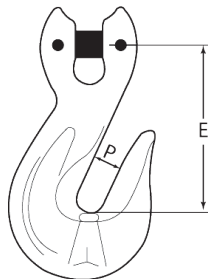

Ref.	Diam (mm)	SWL (t)	E (mm)	P (mm)	Gewicht (kg)	Code art.
A 701	5/6	0,9	34	7	0,12	
A 702	7/8	1,6	53	9	0,24	
A 703	10	2,5	60	12	0,45	
A 704	13	4,25	84,5	15	0,95	
A 705	16	6,4	104	20	1,9	
A 706	18/20	10	118	23	3,15	

Gieterijhaak type B7

GRAAD 80

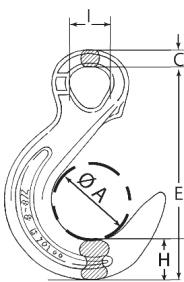

Ref.	Diam (mm)	SWL (t)	A (mm)	C (mm)	I (mm)	E (mm)	H (mm)	Gewicht (kg)	Code art.
B 700	6	1,12	50	10	15	95	24	0,6	
B 701	7/8	2	64	14,5	28,5	136	36	1,1	
B 702	10	3,15	78	18	36,1	166	44	2,1	
B 703	13	5,3	89	20	41	190	51	3,5	
B 704	16	8	102	24	35	207	50	5,3	
B 706	18/20	12,5	114	26	40	235	67	10,6	
B 707	22	15	127	30	47	265	70	13,1	
B 708	24/26	21,2	136	34	54	305	80	17,5	
B 709	32	31,5	152	40	60	327	100	26,5	

Voor hogere lasten, ons te raadplegen.

Lashaak met klep type D16

GRAAD 80

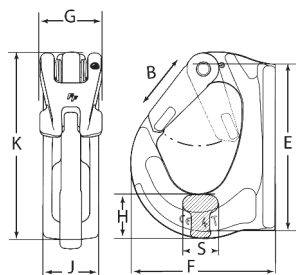

Ref.	SWL (t)	B (mm)	E (mm)	F (mm)	G (mm)	H (mm)	J (mm)	K (mm)	S (mm)	Gewicht (kg)	Code art.
D 1607	0,75	18	76	57	29	22	20	85	15	0,27	
D 1600	1	23	97	71	36	27	26	107	18	0,52	
D 1601	2	23	82	91	36	25	34	115	21	0,84	
D 1615	3	29	117	105	36	31	36	131	24	1,18	
D 1616	4	34	131	114	46	36	43	147	29	1,9	
D 1602	5	34	161	133	47	45	44	173	29	2,55	
D 1603	8	35	166	135	47	52	52	178	39	3	
D 1604	10	49	205	168	47	57	54	222	39	5	

Voor hogere lasten, ons te raadplegen.

Verkortingsklauw type A8/SC

GRAAD 80

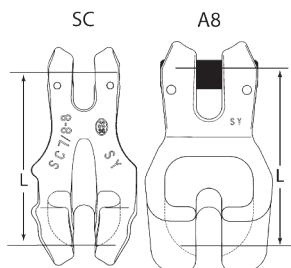

Ref.	Diam. (mm)	SWL (t)	L (mm)	Gewicht (kg)	Code art.
A 801	5/6	1,12	48	0,2	
SC 8	7/8	2	67	0,35	
SC 10	10	3,15	78	0,78	
SC 13	13	5,3	102	1,73	
SC 16	16	8	127	3,5	
A 806	18/20	12,5	143	3,9	

Verkortingsklauw met veiligheid type SCA

GRAAD 80

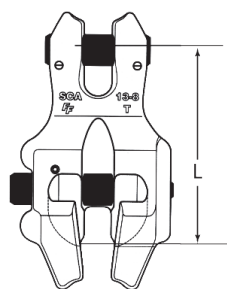

Ref.	Diam. (mm)	SWL (t)	L (mm)	Code art.
SCA 8	7/8	2	67	
SCA 10	10	3,15	78	
SCA 13	13	5,3	102	

Container haak type CH

GRAAD 80

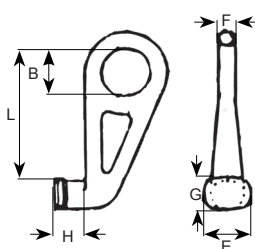

- Zijn ook beschikbaar gedraaid naar rechts of links.

Ref.	SWL (t)	L (mm)	B (mm)	H (mm)	F (mm)	G (mm)	E (mm)	Gewicht (kg)	Code art.
CH-3	12,5	192	70	46	25	47	75	14	

Glijhaak voor staalkabel type B8

GRAAD 80

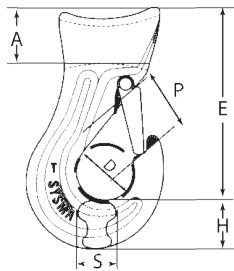

Ref.	Diam. (mm)	SWL (t)	A (mm)	D (mm)	E (mm)	H (mm)	P (mm)	S (mm)	Gewicht (kg)	Code art.
B 801 L	9/13	1,5	17	30	85	24	24	18	0,62	
B 803 L	14/16	2,5	22	34	100	27	27	21	0,95	
B 805 L	17/19	3,75	27	42	128	32	36	25	1,82	
B 808 L	20/26	6,25	32	40	140	39	43	33	3,63	

Klephaak voor platte hijsbanden type D11

GRAAD 80

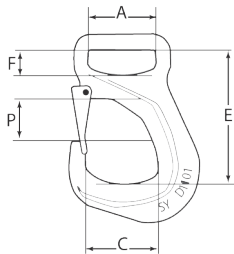

Ref.	Diam. hijsband (mm)	SWL (t)	A (mm)	C (mm)	E (mm)	F (mm)	P (mm)	S (mm)	Gewicht (kg)	Code art.
D 1101 R/1	50	2	55	59	104	20	27	33	1,06	
D 1102 R/1	75	2,75	81	78	140	24	36	40	2,2	

Glijhaken voor kettingen type A16

GRAAD 80

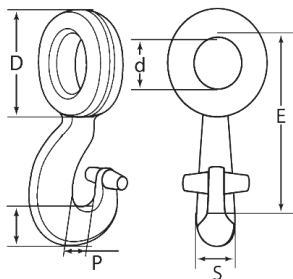

Ref.	Diam. (mm)	SWL (t)	D (mm)	d (mm)	E (mm)	H (mm)	P (mm)	S (mm)	Gewicht (kg)	Code art.
A 161	7/8	2	52	31	91	20	16,5	16,5	0,4	
A 162	10	3,15	67,5	38,5	114	23	20	17,5	0,75	
A 163	13	5,3	85	52	146	31	27	21	1,43	
A 164	16	8	107	63,5	180	38,5	30	30	3,15	

Verbindingsschalm type A12

GRAAD 80

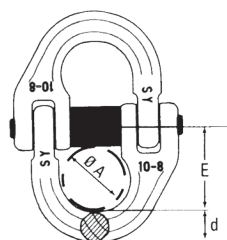

Ref.	Diam. (mm)	SWL (t)	A (mm)	d (mm)	E (mm)	Gewicht (kg)	Code art.
A 1201	6	1,12	15	8	23	0,07	
A 1202/7	7	1,5	20	9	29	0,15	
A 1202/8	8	2	20	11	28	0,16	
A 1203	10	3,15	25	12	34,5	0,3	
A 1204	13	5,3	30	16	42	0,6	
A 1205	16	8	35	22	51	1,2	
A 1206	18/20	12,5	40	24	60	1,9	
A 1207	22	15	45	27	70	2,8	
A 1208	24/26	21,2	50	32	75	4,2	
A 1209	32	31,5	55	40	86	8,4	

Verbindingsschalm ketting/hijsband type A13

GRAAD 80

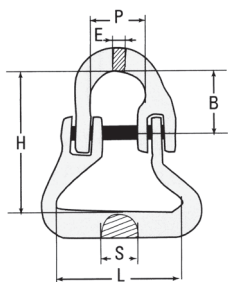

Ref.	Diam. Hijsband (mm)	SWL (t)	H (mm)	L (mm)	S (mm)	B (mm)	P (mm)	E (mm)	Gewicht (kg)	Code art.
A 1302	7/8	50	2	65	50	26	22	20	9	0,3
A 1303	10	59	3,15	76	59	31	26	25	11	0,52
A 1304	13	75	5,3	92	75	35	31	26	15	1

Omega schalm type A4

GRAAD 80

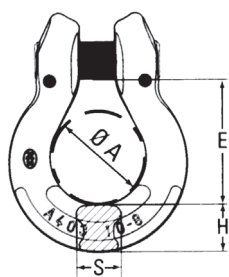

Ref.	Diam. (mm)	Sling (mm)	SWL (t)	A (mm)	E (mm)	H (mm)	S (mm)	Gewicht (kg)	Code art.
A 401	6	7/32	1,12	18	25	11	8,5	0,1	
A 402	7/8	5/16	2	22	35	16	12	0,2	
A 403	10	3/8	3,15	28	41	16	15	0,3	
A 404	13	1/2	5,3	38	53	21	20	0,6	
A 405	16	5/8	8	46	66	28,5	25	1,15	
A 406	18/20	3/4	12,5	56	81	34,5	30	2	

Enkele ringen type A30/B1 A

GRAAD 80

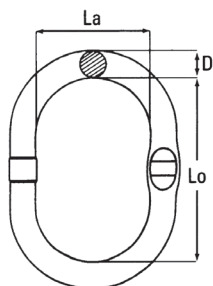

Ref.	SWL (t)	D (mm)	Lo (mm)	La (mm)	Gewicht (kg)	Code art.
A 301	2	13	100	60	0,32	
A 302	3,15	16	120	70	0,6	
A 303	5,3	18	135	75	0,85	
A 304	6,2	20	150	90	1,15	
A 305	9	22	150	90	1,4	
A 306	10	25	170	95	2	
A 306 B	12	28	200	120	3	
A 307	15	30	200	120	3,5	
A 307 B	21,2	36	270	150	6,2	
A 308	25	38	270	158	7	
A 309	30	45	280	170	11,5	
B1 A 30T	37	45	300	200	13	
B1 A 40T	50	50	300	200	16	
B1 A 50T	63	55	350	210	22	
B1 A 80T	100	70	400	250	40	
B1 A 100T	125	80	400	250	53	

Driedubbele ringen type A31

GRAAD 80

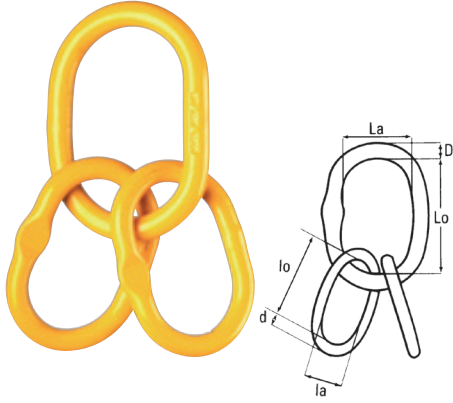

Ref.	SWL (t)	D (mm)	Lo (mm)	La (mm)	d (mm)	lo (mm)	la (mm)	Gewicht (kg)	Code art.
A 311	2,5	16	120	70	13	100	60	1,2	
A 312	3,5	18	130	75	16	100	60	1,8	
A 312 B	5	20	150	90	16	100	60	2,2	
A 313	8	22	150	90	18	120	70	2,9	
A 314	8,5	25	170	95	20	120	70	3,9	
A 315	10	28	200	120	20	120	70	4,9	
A 316	16	30	200	120	22	135	75	5,9	
A 317	17	36	250	150	25	135	75	9,8	
A 317 B	20	38	250	150	28	200	95	11,5	
A 318	30	45	280	170	33	200	120	19,7	
A 318 B	30	46	300	200	36	150	120	24	
A 319	40	50	300	200	38	150	95	25	
A 320	50	55	300	200	38	150	90	28	
A 321	60	60	350	200	40	150	90	35	
A 322	80	70	400	250	55	300	150	75	
A 323	100	80	400	250	60	300	150	93	

Ring voor kraanhaken type ZA3

GRAAD 80

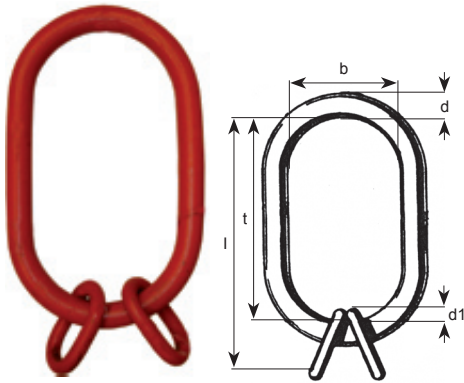

Ref.	SWL (kg)	Ring N°16				Ring N°25				Ring N°40				
		d/d1 (mm)	I (mm)	txb (mm)	Gewicht (kg)	d/d1 (mm)	I (mm)	Gewicht (kg)	txb (mm)	Gewicht (kg)	d/d1 (mm)	I (mm)	txb (mm)	Gewicht (kg)
ZA 3-06	2100	22/13	314	260 x 180	2,55	24/13	394	3,7	340 x 180	3,7	26/13	484	430 x 220	5,25
ZA 3-08	4250	26/16	330	260 x 180	3,85	28/16	410	5,35	340 x 180	5,35	30/16	500	430 x 220	7,3
ZA 3-10	6700	30/18	345	260 x 180	5,3	32/18	435	7,2	340 x 180	7,2	34/18	515	430 x 220	9,6
ZA 3-13	10000	34/22	375	260 x 180	7,65	38/22	455	11	340 x 180	11	40/22	545	430 x 220	14,15
ZA 3-16	17000	36/26	400	260 x 180	9,95	40/26	480	13,5	340 x 180	13,5	42/26	570	430 x 220	16,95
ZA 3-18	21200	45/32	490	260 x 180	18,9	45/32	490	18,9	340 x 180	18,9	48/32	580	430 x 220	23,85
ZA 3-20	26500	51/32	500	260 x 180	23,3	51/32	500	23,3	340 x 180	23,3	55/32	580	430 x 220	29,8
ZA 3-22	32000	51/36	520	260 x 180	25,85	51/36	520	25,85	340 x 180	25,85	55/36	600	430 x 220	32,35
ZA 3-26	40000	57/40	570	260 x 180	35,2	57/40	570	35,2	340 x 180	35,2	63/40	600	430 x 220	43
ZA 3-30	58000	63/45	610	260 x 180	47	63/45	610	48	340 x 180	48	63/45	610	430 x 220	47
ZA 3-32	63000	72/51	660	260 x 180	67,6	72/51	660	67,6	340 x 180	67,6	72/51	660	430 x 220	67,6

Peerringen met gaffel type A2

GRAAD 80

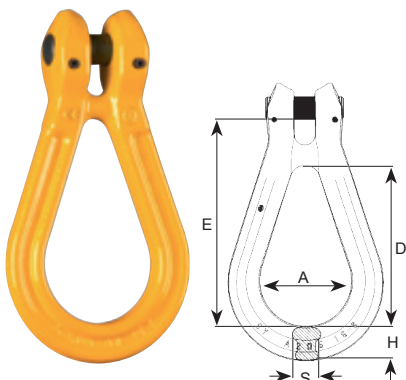

Ref.	Diam. (mm)	SWL (t)	A (mm)	D (mm)	E (mm)	H (mm)	S (mm)	Gewicht (kg)	Code art.
A 202	7/8	2	39	69	87	14	10	0,25	
A 203	10	3,15	48,5	85,5	108	17	14	0,5	
A 204	13	5,3	64	109	136	21	18	1,1	
A 205	16	8	79	139	180	30,5	25,5	2,65	

Veiligheidshaak met gaffel type KHX C en FA6 XVK

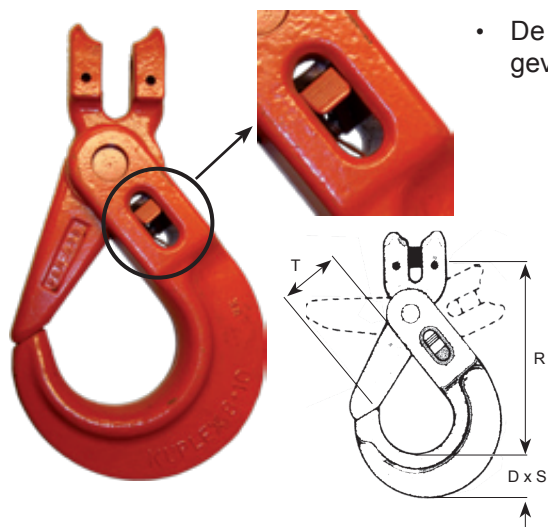

- De vergrendeling van deze haak is geplaatst op de zijkant, wat haar in sommige gevallen beter beschermt.

Ref.	Diam. ketting (mm)	SWL (t)	R (mm)	D (mm)	S (mm)	T (mm)	Gewicht (kg)	Code art.
KHX 7 C	7	2	117	25	19	36	0,8	
KHX 10 C	10	4	146	32	24	47	1,5	
KHX 13 C	13	6,7	181	42	30	56	3,2	
KHX 16 C	16	10	223	49	36	70	5,3	
FA 605XVK	18/20	16	238	52	51	81	8,4	
FA 606 XVK	22	19	282	61	50	95	12,2	
FA 607XVK	26	27	330	78	53	87	22,5	

Haken voor holle welfsels type HOUR

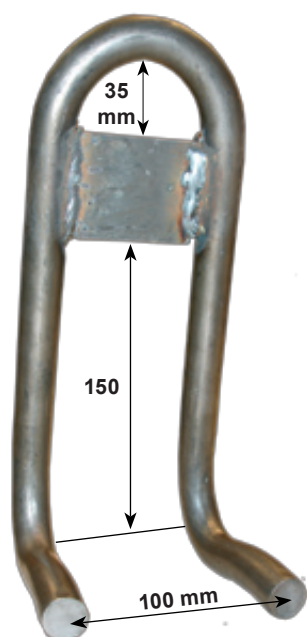

SWL 700 kg
Ref. HOUR700

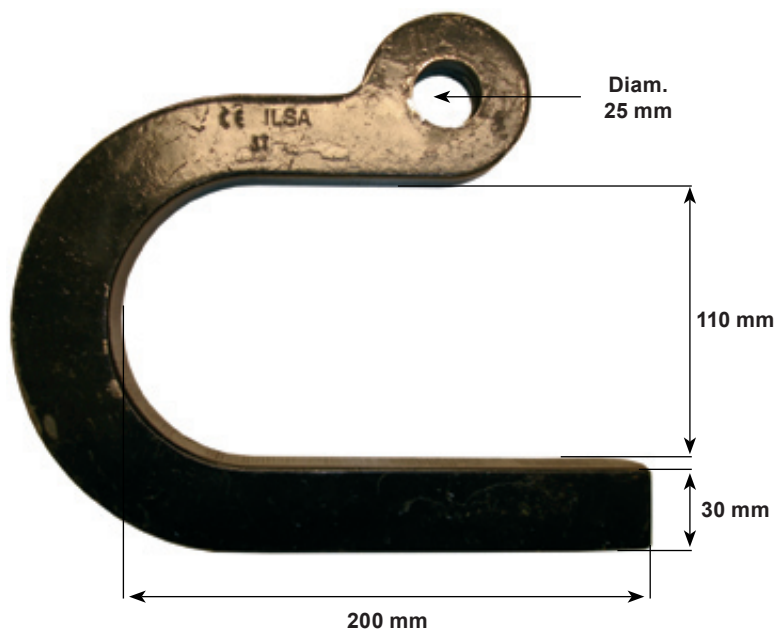

SWL 1000 kg
Staal St52
Geleverd met sluiting
Ref. HOUR1000

Vervangas voor gaffels type DG



Ref.	Voor de volgende haken			Code art.
DG 6	A 401	A 501	A 600	
DG 8	DKC 1	A 402	CCL8	A 601
DG 10	DKC 2	A 403	CCL10	A 602
DG 13	DKC 3	A 404	CCL13	A 603
DG 16	DKC 4	A 405	A 505	A 604
DG 20	A 406	A 506	A 605	
DG 22			A 606	

Vervang klepset type LS

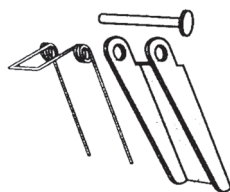

Ref.	Voor de volgende haken						Code art.
LS 1	B 406	B 801	B 902	A 501	B 202S	B 406	
LS 2			B 803L	A 502	B 204S	B 408	
LS 3			B 805L	A 503	B 206S	B 410	
LS 4				A 504	B 208S	B 413	
LS 5	A 505	A 506	B 210S	B 212S	B 416		

Vervang klepset in gesmeed staal type RECH LF

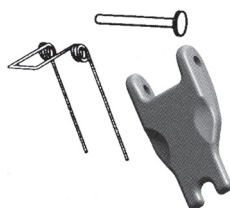

Ref.	Voor de volgende haken				Code art.
RECH LF 7/8	CCL 8	COL 8	CEL 8	CELA 8	
RECH LF 10	CCL 10	COL 10	CEL 10	CELA 10	
RECH LF 13	CCL 10	COL 13	CEL 13	CELA 13	

Vervangset voor veiligheidshaken CL type Rechange

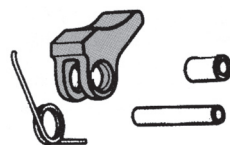

Ref.	Voor de volgende haken			Code art.
Rechange 0	A 600	B 506	B 606 E	
Rechange 1	A 601	B 507	B 607 E	
Rechange 2	A 602	B 508	B 608 E	
Rechange 3	A 603	B 509	B 609 E	
Rechange 4	A 604	B 510	B 610 E	
Rechange 4/1	A 604/1	B 510/1	B 610 E/1	
Rechange 5	A 605	B 511	B 611 E	
Rechange 6	A 606	B 512		

Vervang klepset in gesmeed staal voor de lashaken type Rechange CG

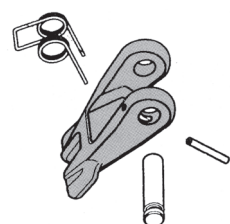

Ref.	Voor de volgende haken			Code art.
Rechange CG 0			D 1607	
Rechange CG 1	D 1600	D 1601	D 1615	
Rechange CG 2	D 1616	D 1602	D 1603	
Rechange CG 4			D 1604	

Open «S» haken type C15

GRAAD 80

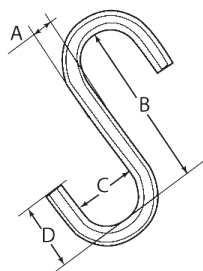

Ref.	SWL (t)	A (mm)	B (mm)	C (mm)	D (mm)	Gewicht (kg)	Code art.
C 1501	0,1	8	80	25	30	0,07	
C 1502	0,15	10	100	30	35	0,14	
C 1503	0,18	13	130	40	40	0,3	
C 1504	0,3	16	160	50	50	0,6	
C 1505	0,4	18	184	54	56	0,8	
C 1506	0,6	20	200	60	60	1,2	
C 1507	0,8	22	222	65	80	1,5	
C 1508	1	25	260	90	90	2,4	
C 1509	1,1	30	310	100	110	5	
C 1510	1,5	36	360	110	125	6,6	
C 1511	2	40	400	120	140	8	

Gesloten «S» haken type C16

GRAAD 80

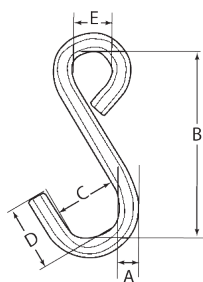

Ref.	SWL (t)	A (mm)	B (mm)	C (mm)	D (mm)	E (mm)	Gewicht (kg)	Code art.
C 1601	0,1	8	77	25	25	16	0,07	
C 1602	0,15	10	80	30	35	20	0,14	
C 1603	0,18	13	130	40	40	24	0,3	
C 1604	0,3	16	140	50	45	32	0,6	
C 1605	0,4	18	160	56	56	36	0,8	
C 1606	0,6	20	170	60	60	40	1,2	
C 1607	0,8	22	180	65	80	44	1,5	
C 1608	1	25	200	90	90	50	2,4	

Meili open «S» haken type 82.7100

GRAAD 80

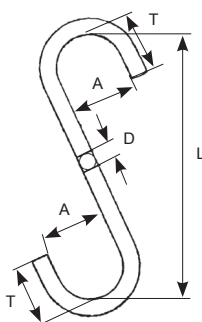

- Grote SWL.
- Kunnen ook als gesloten «S» haken geleverd worden.

Ref.	SWL (kg)	D (mm)	L (mm)	A (mm)	T (mm)	Gewicht (kg)	Code art.
82.7100.08	125	8	115	28	28	0,1	
82.7100.10	250	12	153	38	38	0,2	
82.7100.13	350	14	191	50	50	0,4	
82.7100.16	500	16	229	63	63	0,8	
82.7100.19	750	19	267	76	76	1,2	
82.7100.22	1000	22	305	88	88	1,9	
82.7100.26	1300	26	331	101	101	2,7	
82.7100.28	1500	28	381	114	114	3,9	
82.7100.32	2000	32	407	127	127	5,3	
82.7100.35	2400	36	432	139	139	7	
82.7100.38	2800	38	458	152	152	8,8	

Ooghaken met klep type 320A

GRAAD 80

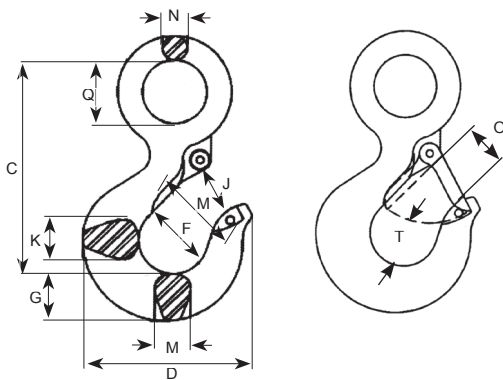

Ref.	SWL (t)	C (mm)	D (mm)	F (mm)	G (mm)	J (mm)	K (mm)	M (mm)	N (mm)	O (mm)	Q (mm)	T (mm)	Gewicht (kg)	Code art.
320/1,25	1,25	85	72	31,8	18,5	22,9	16	16	9,14	22,6	19,1	22,1	0,28	
320/1,6	1,6	97	79	35,1	21,3	23,6	18	18	10,7	23,1	23,1	24,9	0,4	
320/2,5	2,5	105	89,5	38,1	25,4	25,4	22,4	22,4	14	25,4	28,7	26,2	0,65	
320/3,2	3,2	119	101	41,4	28,7	28,7	23,9	23,9	14,7	27,7	31,8	29,5	0,94	
320/5,4	5,4	147	122	51	36,6	37,3	33,3	33,3	18,3	34,5	39,6	38,9	1,95	
320/8	8	187	159	63,5	46	44,5	42,2	42,2	22,9	40,9	51	49,8	3,76	
320/11,5	11,5	230	189	76	57	58	47,8	41,4	28,2	53	62	62,5	6,8	
320/16	16	256	211	82,5	66	63,5	55,5	49,3	32,3	57,5	72	66,5	9,8	
320/22	22	318	262	108	76	84	68,5	60,5	39,6	76,5	89	72	17,9	
320/31,5	31,5	357	346	127	92	102	6	76,2	44,5	82,5	89	87,5	27,2	
320/37	37	462	357	137	116	108	102	81	51	76	114	98,5	47,6	
320/45	45	511	392	152	129	121	114	82,6	55,4	86	125	121	67	
320/60	60	602	470	178	152	146	140	99,3	64,3	105	145	145	103	

Wartelhaken met klep type 322A

GRAAD 80

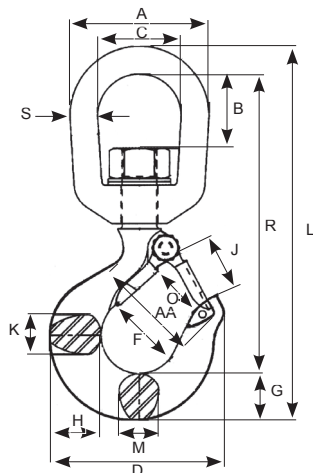

Ref.	SWL (t)	A (mm)	B (mm)	C (mm)	D (mm)	F (mm)	G (mm)	H (mm)	J (mm)	K (mm)	L (mm)	M (mm)	O (mm)	R (mm)	S (mm)	AA (mm)	Gewicht (kg)	Code art.
322/1,25	1,25	51	20,8	31,8	72,5	31,8	18,5	20,6	23,6	16	144	16	23,6	116	9,65	38,1	0,34	
322/1,6	1,6	63,5	33,3	38,1	80	35,1	21,3	23,9	25,6	18	170	18	24,6	136	12,7	50,8	0,57	
322/2,5	2,5	76	38,1	44,5	91	38,1	25,4	29,5	26,9	22,4	197	22,4	26,9	155	16	50,8	1,02	
322/3,2	3,2	76	38,1	44,5	102	41,4	28,7	33,3	30,2	23,9	210	23,9	29,5	165	16	50,8	1,04	
322/5,4	5,4	89	41,7	50,8	123	51	36,6	41,4	38,1	28,7	246	28,7	35,8	191	19,1	63,5	2,25	
322/8	8	116	58	63,5	160	63,5	46	52,5	45,2	36,6	317	36,6	42,9	3245	25,4	76,2	4,67	
322 /11,5	11,5	127	64,5	70	192	76	57	67	51	41,4	375	41,4	56,5	289	28,7	101	7,34	
322/16	16	143	63	79	212	82,5	66	74,5	66,5	49,3	417	49,3	61	311	31,8	101	10,5	
322/22	22	180	95,5	104	263	108	76	89	86,5	60,5	542	60,5	81	424	38,1	127	21	
322/31,5	31,5	180	95,5	104	346	127	93	118	102	76,2	590	76,2	82,6	459	38,1	165	32	

Snaphaak type G-3315

GRAAD 80

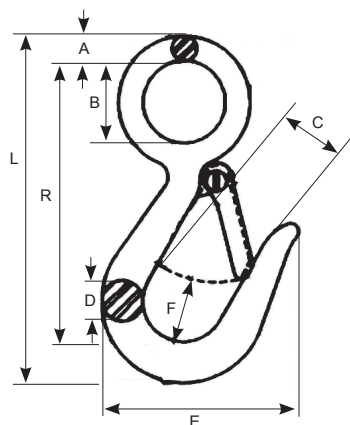

SWL (t)	A (mm)	B (mm)	C (mm)	D (mm)	E (m)	F (mm)	L (mm)	R (mm)	Gewicht (kg)	Code art.
0,34	6,35	19,1	19,1	11,2	57	19,1	100	82,5	0,34	
0,45	8,65	28,4	20,6	14,2	68,5	22,4	120	97,5	0,45	

Vatenhaak type A-377

GRAAD 80



SWL per paar (t)	Binnen-diam. oog (mm)	Buiten-diam. oog (mm)	Totale lengte (mm)	Breedte haak (mm)	Gewicht per paar (kg)	Code art.
1	39,6	71,4	127	73,2	1,61	

Haak voor pipeline type A-378

GRAAD 80



Type	SWL op de punt (t)	SWL op de base van de haak (t)	Binnen-diam. oog (mm)	Totale lengte (mm)	Max. opening (mm)	Radius onderaan de haak (mm)	Gewicht (kg)	Code art.
zonder hendel	1,8	6,8	35	246	71,4	15,9	2,91	
met hendel	1,8	6,8	35	246	71,4	15,9	2,91	

Klepset type S-4320 voor haken 320A en 322A Crosby

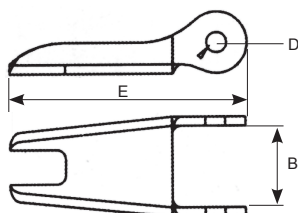

as
+
klep
+
veer

SWL (t)	A (mm)	D (mm)	E (mm)	Gewicht (kg)	Code art.
1,25	12,7	3,8	36,6	0,01	
1,6	13,7	4,3	39,6	0,02	
2	16	4,3	42,2	0,02	
3,2	16,8	4,3	48,5	0,03	
5,4	21,1	5,1	58,5	0,05	
8	26,4	5,1	87,5	0,07	
11,5	31,8	6,85	90,5	0,13	
16	34,3	6,85	97	0,15	
22	42,2	9,9	132	0,38	

Gaffelhaak met klep type CB

GRAAD 80

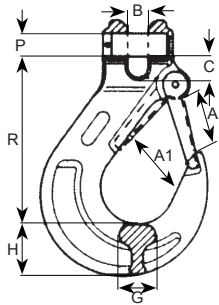

Ref.	Diam. ketting (mm)	SWL (kg)	A (mm)	A1 (mm)	B (mm)	C (mm)	G (mm)	H (mm)	P (mm)	R (mm)	Gewicht (kg)	Code art.
CB 06	6	1120	25	24,5	6,7	8,5	14,5	20	7	73	0,24	
CB 08	7/8	2000	29,5	25,5	8,7	9,8	19	27	9	86,3	0,53	
CB 10	10	3150	35,7	30,5	12,2	13,5	23,5	33	13	105	0,95	
CB 13	13	5300	43,5	41	15,2	17	28,5	40	16	128,5	1,67	
CB 16	16	8000	56	45	18	22	37	48	20	155	3	

Verkortingshaak met oog type CD

GRAAD 80

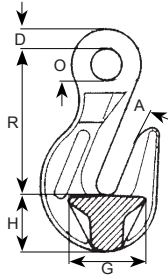

Ref.	Diam. ketting (mm)	SWL (kg)	A (mm)	D (mm)	G (mm)	H (mm)	O (mm)	R (mm)	Gewicht (kg)	Code art.
CD 08	7/8	2000	10	10	30	24	16	60	0,23	
CD 10	10	3150	13	11	44	31	21	80	0,59	
CD 13	13	5300	17	16	53	38	26	104	1,24	
CD 16	16	8000	20	19	64	44	30	114	2,01	

Veiligheidshaak met oog type CRO

GRAAD 80

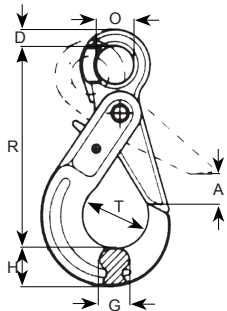

Ref.	Diam. ketting (mm)	SWL (kg)	A (mm)	D (mm)	G (mm)	H (mm)	O (mm)	R (mm)	T (mm)	Gewicht (kg)	Code art.
CRO 06	6	1120	28	11	16	21	21	109	35	0,51	
CRO 08	7/8	2000	34	12	20	26	25	135	43	0,936	
CRO 10	10	3150	45	16	25	30	33	168	56	1,626	
CRO 13	13	5300	51	20	35	40	40	205	69	3,25	
CRO 16	16	8000	60	27	36	50	50	251	80	6,05	

Veiligheidshaak met gaffel type CRF

GRAAD 80

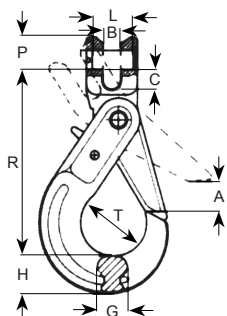

Ref.	Diam. ketting (mm)	SWL (kg)	A (mm)	B (mm)	C (mm)	G (mm)	H (mm)	R (mm)	T (mm)	PxL	Gewicht (kg)	Code art.
CRF 06	6	1120	28	7	8	16	21	94	35	7,5x17,5	0,496	
CRF 08	7/8	2000	34	9	10	20	26	123	43	9x22,5	0,934	
CRF 10	10	3150	45	12	14	25	30	143	56	13x31,5	1,58	
CRF 13	13	5300	51	15	17	35	40	180	69	16x42	3,2	
CRF 16	16	8000	60	19	19	36	50	215	80	21x51,5	5,95	

Verbindingsschalm type CL

GRAAD 80

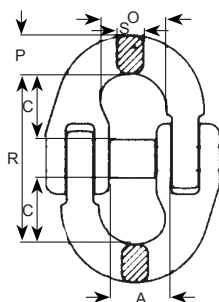

Ref.	Diam. ketting (mm)	SWL (kg)	A (mm)	C (mm)	O (mm)	R (mm)	P (mm)	S (mm)	Gewicht (kg)	Code art.
CL 06	6	1120	16	18	16,5	43	7,2	6,8	0,07	
CL 07	7	1500	18,5	20	20	49	8,5	7,7	0,1	
CL 08	8	2000	22,7	26	27	70	9,4	9	0,25	
CL 10	10	3150	25	32	27	77	12	11	0,35	
CL 13	13	5300	30	35	32	85	15,5	15,5	0,68	
CL 16	16	8000	33	40	39	103	21	21	1,1	

Hijsketting type A1X

GRAAD 100



Ref.	Diam. (mm)	SWL (t)	Pas (mm)	W1 (mm)	W2 (mm)	Gewicht (kg)	Code art.
A 101 X	6	1,4	18	7,8	22,2	0,9	
A 102 X	7	1,9	21	9,1	25,9	1,1	
A 103 X	8	2,5	24	10,9	26,9	1,6	
A 104 X	10	4	30	13	37	2,2	
A 105 X	13	6,7	39	16,9	48,1	3,6	
A 106 X	16	10	48	20,8	59,2	5,4	
A 100 X	19	14	57	24,7	70,3	8	
A 107 X	20	16	60	26	74	10	
A 108 X	22	19	66	29,5	73,5	12	
A 109 X	26	27	78	33,8	96,2	15	

Veiligheidshaak met gaffel type A6X

GRAAD 100

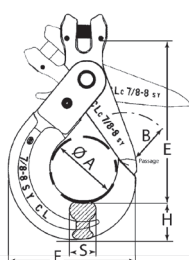

Ref.	Diam. (mm)	SWL (t)	A (mm)	B (mm)	E (mm)	F (mm)	H (mm)	S (mm)	Gewicht (kg)	Code art.
A 600 X	6	1,4	34	30	88	75	24	15	0,5	
A 601 X	7/8	2,5	46	38	111	87	26	18	0,75	
A 602 X	10	4	56	44	142	106	33	24	1,5	
A 603 X	13	6,7	71	57	173	137	43	34	3,1	
A 604 X	16	10	88	64	213	170	46	36	5,9	
A 605 X	18/20	16	100	80	239	197	55	52	7,4	
A 606 X	22	19	113	95	281	225	64	53	12,5	
A 607 X	24/26	27	125	87	319	253	78	52	22,5	

Veiligheidshaak met oog type B5X

GRAAD 100

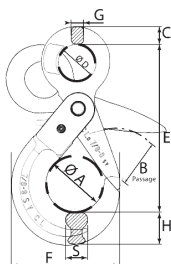

Ref.	Diam. (mm)	SWL (t)	A (mm)	B (mm)	C (mm)	D (mm)	E (mm)	F (mm)	G (mm)	H (mm)	S (mm)	Gewicht (kg)	Code art.
B 506 X	6	1,4	34	30	10	22	110	75	10	24	15	0,5	
B 507 X	7/8	2,5	45	37	14	29	133	88	10	27	19	0,8	
B 508 X	10	4	56	45	15	36	167	106	12	33	25	1,55	
B 509 X	13	6,7	71	50	21	45	200	138	16	42	33	3,15	
B 510 X	16	10	88	64	28	58	251	172	20	46	35	6,05	
B 511 X	18/20	16	100	80	27	64	274	197	21	55	52	7,6	
B 512 X	22	19	113	95	35	71	314	225	26	64	53	12,6	
B 513 X	24/26	27	125	87	40	80	371	253	33	78	52	23	

Gaffelhaak met klep type CCLX

GRAAD 100

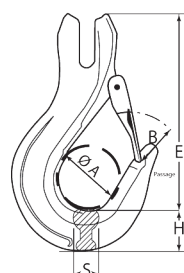

Ref.	Diam. (mm)	SWL (t)	A (mm)	B (mm)	E (mm)	H (mm)	S (mm)	Gewicht (kg)	Code art.
A 501 X	6	1,4	34	18	74	19	15	0,28	
CCL 8 X	7/8	2,5	40	29	99	21	20	0,55	
CCL 10 X	10	4	46	32	120	25	27	1,1	
CCL 13 X	13	6,7	52	42	136	35	30	1,9	
A 505 X	16	8	68	48	168	46	36	3,8	

Ooghaak met klep type COLX

GRAAD 100

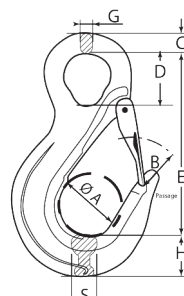

Ref.	Diam. (mm)	SWL (t)	A (mm)	B (mm)	C (mm)	D (mm)	E (mm)	G (mm)	H (mm)	S (mm)	Gewicht (kg)	Code art.
B202 X	6	1,4	34	22	10	20	86	9	18	15	0,27	
COL 8 X	7/8	2,5	40	29	11	27	112	10	21	20	0,55	
COL 10 X	10	4	46	33	13	34	131	13	24	26	1	
COL 13 X	13	6,7	52	40	18	44	152	17	35	30	1,8	
B210 X	16	10	68	48	22	54	182	19	44	34	3	

Veiligheidshaak met wartel type COLX

GRAAD 100

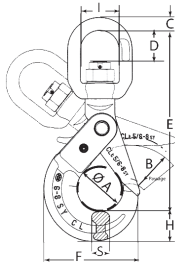

Ref.	Diam. (mm)	SWL (t)	A (mm)	B (mm)	C (mm)	D (mm)	E (mm)	F (mm)	G (mm)	H (mm)	S (mm)	Gewicht (kg)	Code art.
B 606 X	6	1,4	34	30	10	25	144	75	11	24	15	0,6	
B 607 X	8	2,5	45	38	12	30	178	88	12	27	18	1	
B 608 X	10	4	55	44	14	35	208	108	14	33	25	2	
B 609 X	13	6,7	68	50	18	45	252	138	16	44	34	3,8	
B 610 X	16	10	85	66	20	60	322	175	20	46	35	7	
B 611 X	20	16	100	80	28	60	360	190	26	52	40	9,6	
B 612 X	22	19	125	87	33	77	420	254	34	78	53	16,25	

GVerkortingsklauw met veiligheid type SCAUX

GRAAD 100

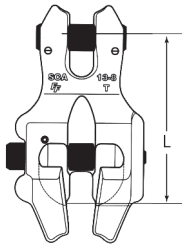

Ref.	Diam. (mm)	SWL (t)	L (mm)	Gewicht (kg)	Code art.
SCAU 8 X	7/8	2,5	67	0,5	
SCAU 10 X	10	4	78	0,78	
SCAU 13 X	13	6,7	102	1,73	
SCAU 16 X	16	10	127	3,5	

Verkortingshaak met oog type XV

GRAAD 100

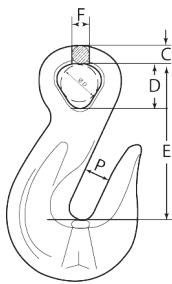

Ref.	Diam. (mm)	SWL (t)	C (mm)	D (mm)	E (mm)	F (mm)	P (mm)	Gewicht (kg)	Code art.
A 712 X	7/8	2,5	10	17	64	11	10	0,34	
A 713 X	10	4	11	26	78	73	12	0,62	
A 714 X	13	6,7							
A 716 X	16	10							

Verbindingsschalm type XVR

GRAAD 100

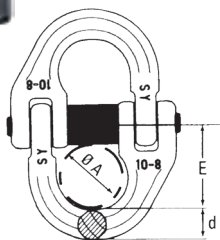

Ref.	Diam. (mm)	SWL (t)	A (mm)	D (mm)	E (mm)	Gewicht (kg)	Code art.
A 1202 X	7/8	2,5	20	11	28	0,16	
A 1203 X	10	4	25	12	34,5	0,3	
A 1204 X	13	6,7	30	16	42	0,6	
A 1205 X	16	10	35	22	51	1,2	

Omega schalm type A4X

GRAAD 100

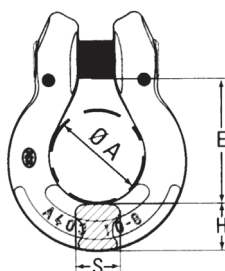

Ref.	Diam. (mm)	SWL (t)	A (mm)	E (mm)	H (mm)	S (mm)	Gewicht (kg)	Code art.
A 401 X	6	1,4	18	25	11	9	0,07	
A 402 X	7/8	2,5	23	36	16	12	0,2	
A 403 X	10	4	32	41	16	15	0,3	
A 404 X	13	6,7	42	53	21	20	0,6	
A 405 X	16	10	50	65	28	25	1,15	

Enkele ring type A30X

GRAAD 100

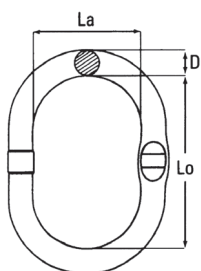

Ref.	SWL (t)	D (mm)	Lo (mm)	La (mm)	Gewicht (kg)	Code art.
A 301 X	1,6	13	100	60	0,32	
A 302 X	3,15	16	120	70	0,6	
A 303 X	5,3	18	135	75	0,85	
A 304 X	6,2	20	150	90	1,15	
A 306 X	11,2	25	195	106	2	
A 307 X	16	30	235	126	3,5	
A 307 BX	21,2	36	270	150	6,25	
A 308 X	25,1	38	270	158	7	
A 309 X	32,1	45	340	180	11,1	

Driedubbele ring type A31X

GRAAD 100

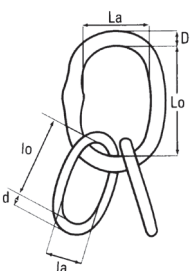
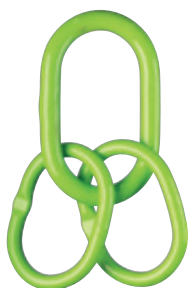

Ref.	SWL (t)	D (mm)	Lo (mm)	La (mm)	d (mm)	lo (mm)	la (mm)	Gewicht (kg)	Code art.
A 311 X	2,5	16	120	70	13	100	60	1,2	
A 312 BX	5,5	20	150	90	18	135	75	2,75	
A 314 X	8,5	25	195	100	20	150	90	4,6	
A 317 X	17,6	36	265	145	28	200	120	11	
A 317 CX	23,6	40	300	160	32	235	120	16,2	
A 318 X	31,5	45	340	180	38	270	150	32	
A 319 X	40	50	350	200	42	300	160	39	
A 320 X	50	55	400	200	45	340	180	50	
A 321 X	60	58	430	220	50	350	190	64	

Verbindingsschalm type CLX

GRAAD 100

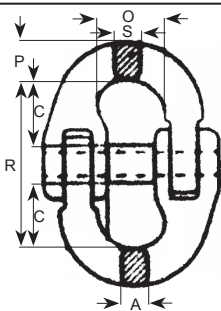

Ref.	SWL (kg)	Diam. ketting (mm)	A (mm)	C (mm)	O (mm)	R (mm)	P (mm)	S (mm)	Gewicht (kg)	Code art.
CLX 06	1400	6	14	18	18	45	8	7,5	0,07	
CLX 07	1900	7	16	20	19	52	10,5	8,80	0,14	
CLX 08	2500	8	18	25	23	62	12	9,5	0,2	
CLX 10	4000	10	23	30	27	70	12	12	0,35	
CLX 13	6700	13	27	36	34	90	20	17	0,74	
CLX 16	10000	16	33	40	39	105	22	20,5	1,16	
CLX 20	16000	20	42	46	46	113	29	25	2,05	
CLX 22	19000	22	49	55	58	133	30	28	3,1	
CLX 26	26500	26	57	85	82,5	192	40	30	6,8	
CLX 32	39500	32								

Veiligheidshaak met oog type CROX

GRAAD 100

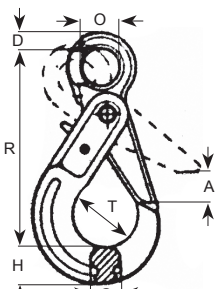

Ref.	Diam. ketting (mm)	SWL (kg)	A (mm)	D (mm)	G (mm)	H (mm)	O (mm)	R (mm)	T (mm)	Gewicht (kg)	Code art.
CROX 06	5-6	1400	28	11	16	21	21	109	35	0,5	
CROX 08	7-8	2500	34	12	20	26	25	135	43	0,96	
CROX 10	10	4000	45	16	25	30	33	168	56	1,65	
CROX 13	13	6700	51	20	35	40	40	205	69	3,25	
CROX 16	16	10000	60	27	36	50	50	251	80	6,1	
CROX 20	20	16000	70	30	60	67	60	290	90	9,8	
CROX 22	22	19000	80	32	62	70	70	322	100	14,4	

Veiligheidshaak met gaffel type CRFX

GRAAD 100

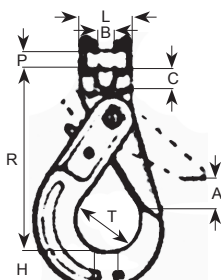

Ref.	Diam. ketting (mm)	SWL (kg)	A (mm)	B (mm)	C (mm)	G (mm)	H (mm)	R (mm)	T (mm)	PxL (mm)	Gewicht (kg)	Code art.
CRFX 06	5-6	1400	28	7	8	16	21	94	35	7,5x17,5	0,5	
CRFX 07	7	1900	34	9	10	20	26	123	43	9x22,5	0,95	
CRFX 08	8	2500	34	9	10	20	26	123	43	10x22,5	0,95	
CRFX 10	10	4000	45	12	14	25	30	143	56	13x31,5	1,6	
CRFX 13	13	6700	51	15	17	35	40	180	69	16x42	3,2	
CRFX 16	16	10000	60	19	19	36	50	215	80	21x51,5	6	
CRFX 20	20	16000	70	23	26	60	67	253	90	24x73	9,8	
CRFX 22	22	19000	82	26	32	62	70	287	100	26x72	14,4	

Gaffelhaak met klep type CBX

GRAAD 100

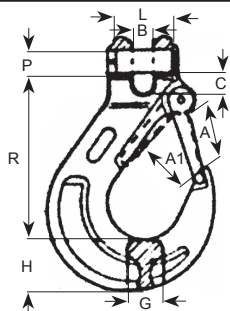

Ref.	Diam. ketting (mm)	SWL (kg)	A (mm)	A1 (mm)	B (mm)	C (mm)	G (mm)	H (mm)	R (mm)	PxL (mm)	Gewicht (kg)	Code art.
CBX 06SF	5-6	1400	26	19	7,2	8	15	20	69	7,5x17,5	0,25	
CBX 07SF	7	1900	34	26	9,5	10	19	28	95	9x22,5	0,55	
CBX 08SF	8	2500	34	26	9,5	10	19	28	95	10x22,5	0,5	
CBX 10SF	10	4000	40	31	12	13,5	25	33	110	13x29,5	1	
CBX 13SF	13	6700	51	40	15	17	30	40	136	16x37	1,7	
CBX 16SF	16	10000	56	45	18	22	37	48	155	20x52	3,2	
CBX 20SF	20	16000	60	53	23	25	51	52	185	24x73	5	
CBX 22SF	22	19000	66	62	25	32	50	63	210	26x72	12,3	

Ooghaak met klep type CAX

GRAAD 100

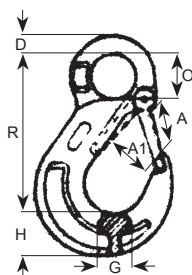

Ref.	Diam. ketting (mm)	SWL (kg)	A (mm)	A1 (mm)	D (mm)	G (mm)	H (mm)	O (mm)	R (mm)	Gewicht (kg)	Code art.
CAX 06SF	5-6	1400	26	19	10	16	20	20,5	81	0,25	
CAX 08SF	7-8	2500	33	26	11	19	29	25	101	0,5	
CAX 10SF	10	4000	40	31	16	26	33	34	131	0,97	
CAX 13SF	13	6700	51	40	19	33	42	43	159	1,9	
CAX 16SF	16	10000	56	45	24,5	40	50	50	183	3,3	
CAX 20SF	20	16000	58	52	27	48	53	55	203	4,5	
CAX 22SF	22	19000	67	62	29	50	60	60	224	7,1	

Verkortingshaak met gaffel type CFX

GRAAD 100

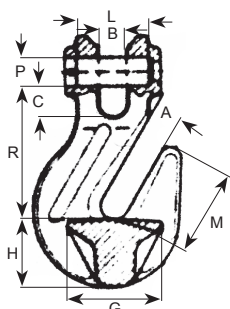

Ref. zonder klep	Ref. met klep	Diam. ketting (mm)	SWL (kg)	A (mm)	B (mm)	C (mm)	G (mm)	H (mm)	R (mm)	M (mm)	PxL (mm)	Gewicht (kg)	Code art.
CFX 06	CFX 06S	6	1400	8	8	8,8	22	22	50,5	35,5	7,5x17,5	0,2	
CFX 07	CFX 07S	7	1900	10	10	11,4	30	28	65,5	47	9x22,5	0,44	
CFX 08	CFX 08S	8	2500	10	10	10,9	30	28	64,9	47	10x23	0,44	
CFX 10	CFX 10S	10	4000	13	13	14,9	34	34	79,9	55	13x31,5	0,96	
CFX 13	CFX 13S	13	6700	17	17	17,4	47	47	105,4	81	16x42	2,1	
CFX 16	CFX 16S	16	10000	19	19	18,3	64	60	111,8	92	21x51,5	3,4	
CFX 20	-	20	16000	23,5	23,5	22	84	65	118	100	24x61,5	5,2	
CFX 22	-	22	19000	26	26	25	92	65	154	120	26x72	7,8	

Verkortingshaak met oog type CDX

GRAAD 100

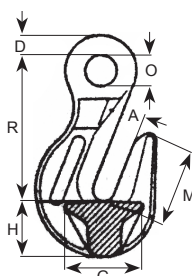

Ref. zonder klep	Ref. met klep	Diam. ketting (mm)	SWL (kg)	A (mm)	D (mm)	G (mm)	H (mm)	O (mm)	R (mm)	M (mm)	Gewicht (kg)	Code art.
CDX 06	CDX 06S	6	1400	8	8,5	22	22	12	51,5	35,5	0,18	
CDX 09	CDX 08S	7-8	2500	10	11	30	28	17	69	47	0,4	
CDX 10	CDX 10S	10	4000	13	15	44	34	22	86,5	55	0,88	
CDX 13	CDX 13S	13	6700	17	18	53	47	26	110,5	81	1,95	
CDX 16	CDX 16S	16	10000	19	21	64	60	32	129	92	3,2	
CDX 20	-	20	16000	23,5	23	85	64	38	153	100	4,9	
CDX 22	-	22	19000	26	26	92	65	41	180	121	7,5	

Verkortingsklauw met veiligheid type CXX

GRAAD 100

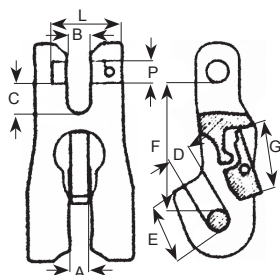

Ref.	Diam. ketting (mm)	SWL (kg)	A (mm)	B (mm)	C (mm)	D (mm)	E (mm)	F (mm)	G (mm)	PxL (mm)	Gewicht (kg)	Code art.
CXX 06	6	1400	8	8	10	8	19	45	23	7,5x17,5	0,21	
CXX 07	7	1900	9,5	9,5	10	9,5	23,5	56	29	9x22,5	0,48	
CXX 08	8	2500	9,5	9,5	10	9,5	23,5	56	29	10x22,5	0,48	
CXX 10	10	4000	12	12	14,5	12	32,5	78	36	13x31,5	1,12	
CXX 13	13	6700	15,5	15,5	18	15,5	44	90	35	16x42	1,83	
CXX 16	16	10000	19	21	21	19	50	106	38	21x51,5	2,83	

Veiligheidshaak met wartel type CRGX

GRAAD 100

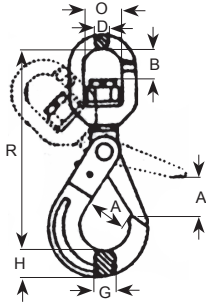

Ref.	Diam. ketting (mm)	SWL (kg)	R (mm)	A (mm)	B (mm)	O (mm)	D (mm)	G (mm)	H (mm)	Gewicht (kg)	Code art.
CRGX 06	5-6	1400	158	28	23	36	13	16	21	0,6	
CRGX 08	7-8	2500	182	34	27	36	13	20	26	1,1	
CRGX 10	10	4000	217	45	35	42	16	25	30	2	
CRGX 13	13	6700	271	54	43	50	21	35	40	4	
CRGX 16	16	10000	320	62	58	62	24	38	50	6,8	

Enkele ring type CMX

GRAAD 100

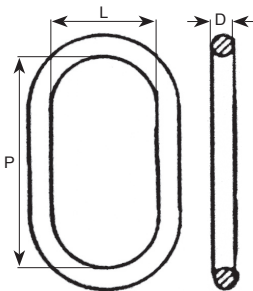

Ref.	Diam. ketting (mm)		SWL (kg)	D (mm)	P (mm)	L (mm)	Gewicht (kg)	Code art.
	1 eind	2 einden						
CMX 0706	7	6	2000	13	110	60	0,34	
CMX 0807	8	7	2500	16	110	60	0,53	
CMX 1008	10	8	4000	18	135	75	0,915	
CMX 1310	13	10	6700	22	160	90	1,6	
CMX 1613	16	13	10000	26	180	100	2,46	
CMX 1816	18	16	14000	32	200	110	4,14	
CMX 2018	20	18	17500	36	260	140	6,22	
CMX 2220	22	20	22400	40	300	160	8,95	
CMX 2622	26	22	26600	45	340	180	12,82	

Driedubbele ring type CMCX

GRAAD 100

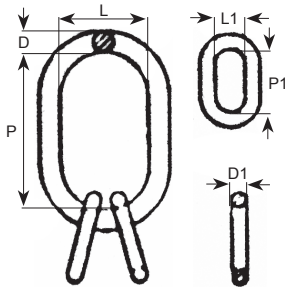

Ref.	Diam. ketting (mm)	SWL (kg)	D (mm)	P (mm)	L (mm)	D1 (mm)	P1 (mm)	L1 (mm)	Gewicht (kg)	Code art.
CMCX 06	6	2000	18	135	75	13	54	25	1,315	
CMCX 07	7	4000	18	135	75	13	54	25	1,315	
CMCX 08	8	5300	22	160	90	16	70	34	2,32	
CMCX 10	10	8000	26	180	100	18	85	40	3,52	
CMCX 13	13	14000	32	200	110	22	115	50	6,26	
CMCX 16	16	21200	36	260	140	26	140	65	9,56	
CMCX 20	20	33600	50	350	190	33	150	70	22,65	
CMCX 22	22	39900	50	350	190	36	170	75	25,19	

Rechange voor haken met klep type CKSX



Ref.	Ketting	Voor de volgende haaken	Code art.
CKSX 06	6	CAX 06 - CBX 06	
CKSX 08	7-8	CAX 08 - CBX 07 - CBX 08	
CKSX 10	10	CAX 10 - CBX 10	
CKSX 13	13	CAX 13 - CBX 13	
CKSX 16	16	CAX 16 - CBX 16	
CKSX 20	20	CAX 20 - CBX 20	
CKSX 22	22	CAX 22 - CBX 22	
CKSX 26	26	CAX 26 - CBX 26	
CKSX 32	32	CAX 26 - CBX 26	

Rechange voor veiligheidshaken type CLSLX



Ref.	Ketting	Voor de volgende haaken	Code art.
CKSLX 06	6	CRFX 06 - CROX 06	
CKSLX 08	7-8	CRFX 08 - CROX 07 - CROX 08	
CKSLX 10	10	CRFX 10 - CROX 10	
CKSLX 13	13	CRFX 13 - CROX 13	
CKSLX 16	16	CRFX 16 - CROX 16	
CKSLX 20	20	CRFX 20 - CROX 20	
CKSLX 22	22	CRFX 22 - CROX 22	

Wartels met kogellager

Type SKLI

- Deze wartels voorkomen het draaien van kabels, kettingen en alle toebehoren waaraan de last hangt.
- Het draaien van de lasten is zo volledig onder controle.
- De staalkabels slijten minder rap wat een langere levensduur met zich meebrengt.
- Het SK systeem bestaat uit een serie speciale Graad 80 hoogwaardige stalen onderdelen voor eenvoudig, veilige montage aan kettingen, staalkabels en hijsbanden, ontworpen om uw hijsproblemen op te lossen.
- Universele verbinding van onderdelen aan ketting, staalkabels en hijsbanden.
- Snelle en eenvoudige montage, U heeft slechts een hamer nodig.
- Gestandaardiseerde afmetingen zorgen ervoor dat onderdelen met verschillende veilige werkbelastingen niet aan elkaar kunnen passen.
- Licht materiaal voor zware lasten ; alle onderdelen zijn gemaakt uit hoogwaardige staal graad 80.

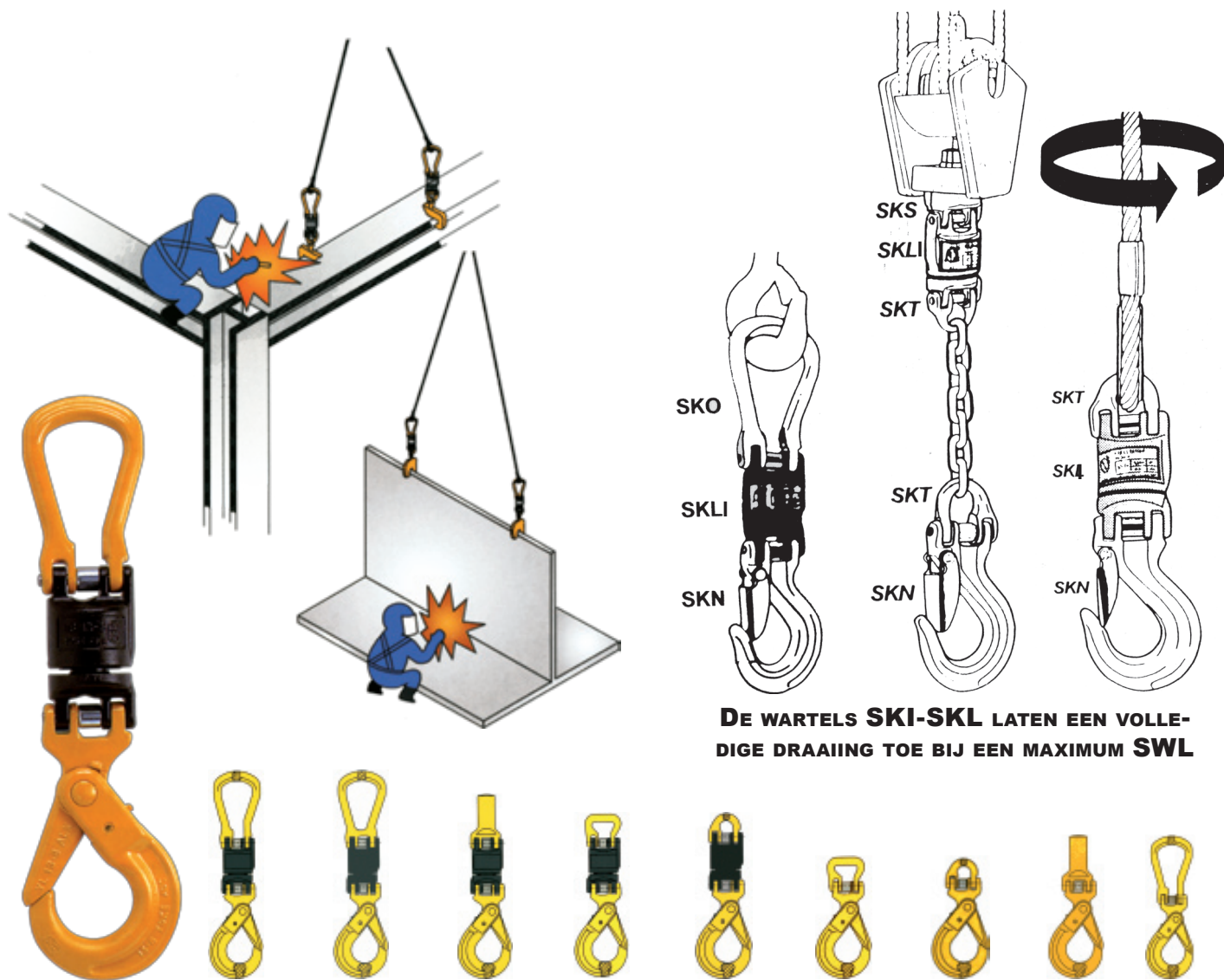

DE WARTELS SKI-SKL LATEN EEN VOLLEDIGE DRAAIING TOE BIJ EEN MAXIMUM SWL

De waterdichte/geïsoleerde wartels op kogellagers tot 1000V type SKLI

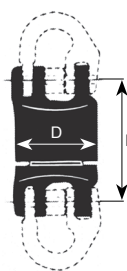

Ref.	SWL (t)	Diam. ketting (mm)	L (mm)	D (mm)	Gewicht (kg)	Code art.
SKLI-7/8-8	2	7,8	71/69	45	0,6	
SKLI-10-8	3,2	10	90/87	57	1,2	
SKLI-13-8	5,4	13	112/109	73	2,1	
SKLI-16-8	8	16	132/127	88	3,8	
SKLI-18/20-8	12,5	19	150/147	104	6,4	

Gesloten ring type SKG

GRAAD 80

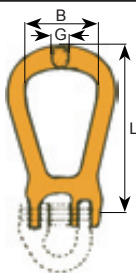

Ref.	SWL (t)	Diam. ketting (mm)	L (mm)	B (mm)	G (mm)	Gewicht (kg)	Code art.
SKG-7/8-8	2	7,8	99	50	14	0,3	
SKG-10-8	3,2	10	127	66	18	0,6	
SKG-13-8	5,4	13	145	72	22	1,1	
SKG-16-8	8	16	175	82	25	1,7	
SKG-18/20-8	12,5	19	204	105	30	2,8	

Open ring type SKO

GRAAD 80

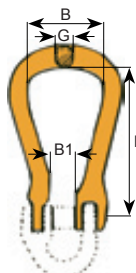

Ref.	SWL (t)	Diam. ketting (mm)	L (mm)	B (mm)	G (mm)	B1 (mm)	Gewicht (kg)	Code art.
SKO-7/8-8	2	7,8	99	50	14	15	0,3	
SKO-10-8	3,2	10	127	66	18	20	0,6	
SKO-13-8	5,4	13	145	72	22	25	1	
SKO-16-8	8	16	175	82	25	30	1,6	
SKO-18/20-8	12,5	19	204	105	30	36	2,6	

Klephaak type SKN

GRAAD 80

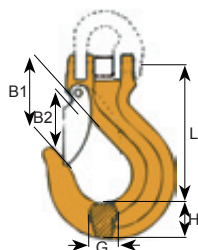

Ref.	SWL (t)	Diam. ketting (mm)	L (mm)	B1 (mm)	B2 (mm)	G (mm)	H (mm)	Gewicht (kg)	Code art.
SKN-7/8-8	2	7,8	90	32	27	18	21	0,4	
SKN-10-8	3,2	10	115	40	34	23	29	0,9	
SKN-13-8	5,4	13	141	48	42	28	36	1,9	
SKN-16-8	8	16	165	56	49	33	43	3,2	
SKN-18/20-8	12,5	19	189	66	59	42	50	5,1	

Verbinding met bout type SKS

GRAAD 80

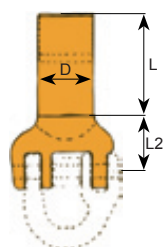

Ref.	SWL (t)	Diam. ketting (mm)	L (mm)	L2 (mm)	D (mm)	d mini (mm)	Gewicht (kg)	Code art.
SKS-7/8-8	2	7,8	70	27	30	13	0,5	
SKS-10-8	3,2	10	85	34	36	16	0,9	
SKS-13-8	5,4	13	100	43	42	20	1,4	
SKS-16-8	8	16	112	52	50	25	2,5	
SKS-18/20-8	12,5	19	88	55	70	30	4,7	

Halve verbindingsschalm type SKT

GRAAD 80

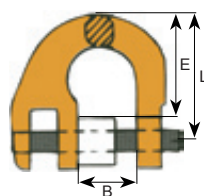

Ref.	SWL (t)	Diam. ketting (mm)	L (mm)	B (mm)	E (mm)	Gewicht (kg)	Code art.
SKT-7/8-8	2	7,8	28	18	22	0,1	
SKT-10-8	3,2	10	34	25	26	0,2	
SKT-13-8	5,4	13	44	29	33	0,4	
SKT-16-8	8	16	52	36	40	0,7	
SKT-18/20-8	12,5	19	63	43	48	1,1	

Veiligheidshaak type YL

GRAAD 80

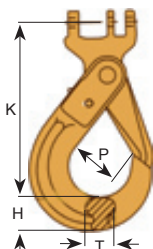

Ref.	SWL (t)	Diam. ketting (mm)	K (mm)	P (mm)	T (mm)	H (mm)	Gewicht (kg)	Code art.
YL-7/8-8	2	7,8	114	35	20	26	0,9	
YL-10-8	3,15	10	123	45	26	34	1,8	
YL-13-8	5,3	13	192	53	30	42	3	
YL-16-8	8	16	207	62	44	55	6	
YL-18/20-8	12,5	18,2	337	94	48	65	6,8	

Voor hogere lasten, gelieve ons te raadplegen

Industrial Lifting
oudstrijdersstraat 31
B-1600 Sint-Pieters-Leeuw (Belgium)
Tel: +32 2 378 06 50 Fax: +32 2 377 58 91

www.ilsa.be
info@ilsa.be

Wartels met klein oog

type G-401

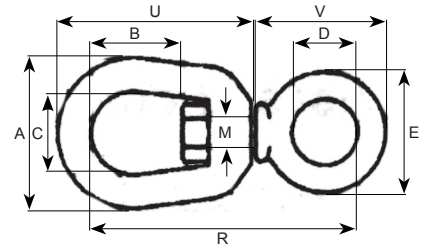
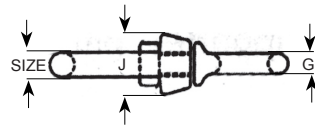

Ref.	Diam. (mm)	SWL (t)	A (mm)	B (mm)	C (mm)	D (mm)	E (mm)	G (mm)	J (mm)	M (mm)	R (mm)	U (mm)	V (mm)	Gewicht (kg)	Code art.
1016233	6	0,39	31,8	17,5	19,1	15,7	28,4	6,35	17,5	7,85	57	42,9	31,8	0,06	
1016251	8	0,57	6,35	41,4	20,6	25,4	19,1	35,1	7,85	20,6	69	52,5	37,3	0,11	
1016279	10	1,02	51	23,9	31,8	25,4	44,5	9,65	25,4	12,7	87,5	63,5	47,8	0,24	
1016297	13	1,63	63,5	33,3	38,1	31,8	57	12,7	33,3	16	108	81	62	0,51	
1016313	16	2,36	76,2	39,6	44,5	38,1	70	15,8	38,1	19,1	130	98,5	74,5	0,95	
1016331	19	3,27	89	44,5	51	44,5	82,5	19,1	47,8	22,4	147	125	88	1,4	

Wartels met groot oog

type G-402

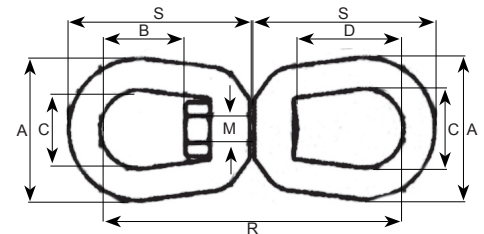
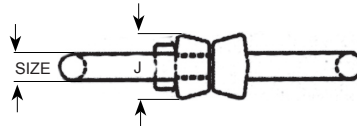

Ref.	Diam. (mm)	SWL (t)	A (mm)	B (mm)	C (mm)	D (mm)	J (mm)	M (mm)	R (mm)	S (mm)	Gewicht (kg)	Code art.
1016019	6	0,39	31,8	17,5	19,1	26,9	17,5	7,85	74,5	42,9	0,1	
1016037	8	0,57	41,4	20,6	25,4	31,8	20,6	9,65	90	52	0,18	
1016055	10	1,02	51	23,9	31,8	38,1	25,4	12,7	109	63,5	0,32	
1016073	13	1,63	63,5	33,3	38,1	51	33,3	16	138	81	0,6	
1016091	16	2,36	76	39,5	44,5	60,5	38,1	19,1	167	98,5	1,13	
1016117	19	3,27	89	44,5	51	67	47,8	22,4	183	109	1,82	
1016135	22	4,54	102	52	57	77,5	54	25,4	213	127	2,83	
1016153	25	5,67	114	58,5	63,5	89	60,5	28,7	245	146	4,06	
1016199	32	8,16	143	68,5	79,5	93,5	76	41,4	291	172	7,42	
1016215	38	20,5	178	98,5	102	106	102	57	435	254	20,8	

Wartels met gaffel

type G-403

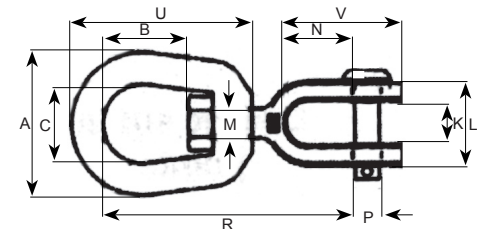
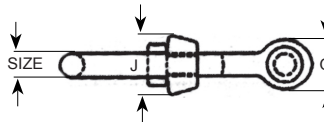

Ref.	Diam. (mm)	SWL (t)	A (mm)	B (mm)	C (mm)	G (mm)	J (mm)	K (mm)	L (mm)	M (mm)	N (mm)	P (mm)	R (mm)	U (mm)	V (mm)	Gewicht (kg)	Code art.
1016395	6	0,39	31,8	17,5	19,1	17,5	17,5	11,9	26,2	7,85	22,4	6,35	67	42,9	42,9	0,1	
1016411	8	0,57	41,4	20,6	25,4	20,6	20,6	12,7	28,7	9,65	22,4	7,85	74,5	52	46	0,15	
1016439	10	1,02	51	23,9	31,8	25,4	25,4	16	35,8	12,7	26,9	9,65	92	63,5	57	0,3	
1016457	13	1,63	63,5	33,3	38,1	33,3	33,3	19,1	44,5	16	33,3	12,7	114	81	73	0,61	
1016475	16	2,36	76	39,5	44,5	41,4	38,1	23,9	52	19,1	38,1	16	135	98,5	87,5	1,12	
1016493	19	3,27	89	44,5	51	47,8	47,8	28,7	64,5	22,4	44,5	19,1	154	109	102	1,76	
1016518	22	4,54	102	52	57	54	54	30,2	70	25,4	52	22,4	178	127	115	2,66	
1016536	25	5,67	114	58,5	63,5	67	60,5	44,5	94,5	28,7	71,5	28,7	217	146	151	4,46	
1016572	32	8,16	145	68,5	79,5	79,5	76	52	109	41,4	71,5	35,1	248	179	162	7,14	
1016590	38	20,5	178	98,5	102	143	102	73	152	57	113	57	374	254	275	24,8	

Gebruiksaanwijzing

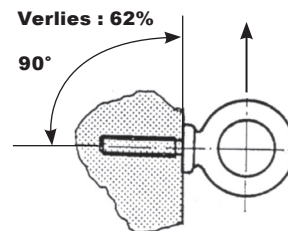
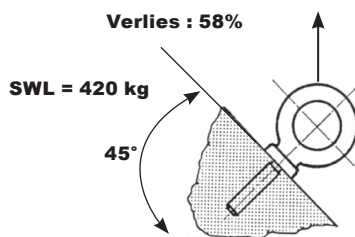
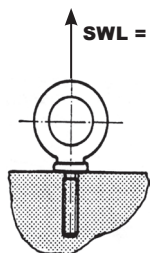

Verzinkte oogbouten type 180

DIN 580

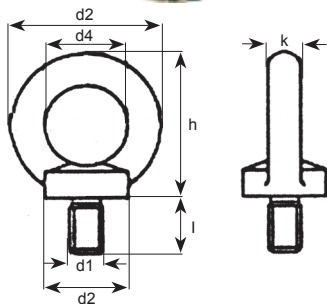

Ref.	SWL (t)	d1 (mm)	d2 (mm)	d3 (mm)	d4 (mm)	h (mm)	k (mm)	l (mm)	Gewicht 100/st (kg)	Code art.
180 L	0,14	M 6	17	28	16	31	6	13	5	
180 A	0,14	M 8	20	36	20	36	8	13	6	
180 B	0,23	M 10	25	45	25	54	10	17	11	
180 C	0,36	M 12	30	54	30	53	12	20,5	18	
180 D	0,36	M 14	35	63	35	62	14	27	26	
180 E	0,7	M 16	35	63	35	62	14	27	28	
180 F	0,7	M 18	40	72	40	71	16	30	45	
180 G	1,2	M 20	40	72	40	71	16	30	45	
180 H	1,2	M 22	45	81	45	80,5	18	35	67	
180 J	1,8	M 24	50	90	50	90	20	36	87	
180 K	1,8	M 27	50	90	50	90	20	38	88	
180 M	3,6	M 30	65	108	60	109	24	45	166	
180 N	3,6	M 33	65	108	60	109	24	45	166	
180 P	5,1	M 36	75	126	70	128	28	54	265	
180 Q	5,1	M 39	85	144	80	147	32	66,3	403	
180 S	7	M 42	85	144	80	147	32	66,3	403	
180 R	7	M 45	100	166	90	168	38	68	638	
180 T	8,6	M 48	100	166	90	168	38	68	638	
180 U	8,6	M 52	110	184	100	187	42	78	880	
180 V	11,5	M 56	110	184	100	187	42	78	880	
180 W	16	M 64	120	206	110	208	48	90	1240	
180 X	21	M 72	150	260	140	260	60	100	2330	

Verzinkte oogmoeren type 190

DIN 582

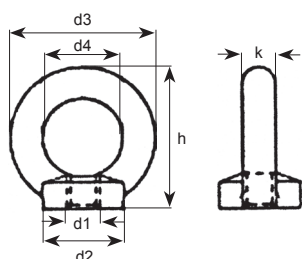

Ref.	SWL (t)	d1 (mm)	d2 (mm)	d3 (mm)	d4 (mm)	h (mm)	k (mm)	Gewicht 100/st (kg)	Code art.
190 L	0,14	M 6	17	28	16	31	6	4,8	
190 A	0,14	M 8	20	36	20	36	8	5	
190 B	0,23	M 10	25	45	25	45	10	9	
190 C	0,36	M 12	30	54	30	53	12	16	
190 D	0,36	M 14	35	63	35	62	14	24	
190 E	0,7	M 16	35	63	35	62	14	24	
190 F	0,7	M 18	40	72	40	71	16	36	
190 G	1,2	M 20	40	72	40	71	16	36	
190 H	1,2	M 22	45	81	45	80,5	18	58	
190 J	1,8	M 24	50	90	50	90	20	72	
190 K	1,8	M 27	50	90	50	90	20	70	
190 M	3,6	M 30	65	108	60	109	24	132	
190 N	3,6	M 33	65	108	60	109	24	130	
190 P	5,1	M 36	75	126	70	128	28	208	
190 Q	5,1	M 39	82	144	80	147	24	202	
190 S	7	M 42	82	144	80	147	32	311	
190 R	7	M 45	100	166	90	168	38	304	
190 T	8,6	M 48	100	166	90	168	38	502	
190 U	8,6	M 52	110	184	100	187	42	495	
190 V	11,5	M 56	110	184	100	187	42	669	
190 W	16	M 64	120	206	110	208	48	930	
190 X	21	M 72 x 6	150	260	140	260	60	1850	

Oogbouten type AL

GRAAD 80

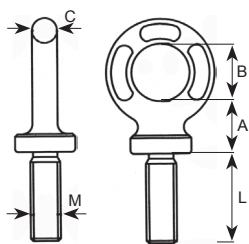

Ref.	SWL (t)		Diam. ISO M/pas	Bruto diam. (mm)	A (mm)	B (mm)	L (mm)	C (mm)	Gewicht (kg)	Code art.
	Coef. 5	Coef. 4								
AL 6	0,2	0,25	M6 x 1	12	18	20	20	6	0,05	
AL 8	0,4	0,5	M8 x 1,25	12	16	20	23	7	0,05	
AL 10	0,7	0,875	M10 x 1,5	14	19	22	30	8	0,07	
AL 12	1	1,25	M12 x 1,75	1	22	27	36	10	0,13	
AL 14	1,2	1,5	M14 x 2	18	28	30	41	14	0,24	
AL 16	1,5	1,875	M16 x 2	22	30	36	53	15	0,36	
AL 18	2	2,5	M18 x 2,5	22	30	36	53	15	0,38	
AL 20	2,5	3,125	M20 x 2,5	26	32	40	58	16	0,55	
AL 22	3	3,75	M22 x 2,5	28	38	45	64	19	0,73	
AL 24	4	5	M24 x 3	30	42	54	64	20	1,08	
AL 27	5	6,25	M27 x 3	30	42	54	64	20	1,18	
AL 30	6	7,5	M30 x 3,5	40	49	60	98	24	1,87	
AL 33	7	8,75	M33 x 3,5	40	49	60	98	24	1,99	
AL 36	8	10	M36 x 4	41	45	68	118	25	2,44	
AL 39	9	11,25	M39 x 4	41	45	68	118	25	2,8	
AL 42	10	12,5	M42 x 4,5	50	56	80	135	31	3,97	
AL 45	15	18,75	M45 x 4,5	50	56	80	135	31	4,23	
AL 48	18	22,5	M48 x 5	72	63	97	150	42	10,2	
AL 52	20	25	M52 x 5	72	63	97	150	42	10,4	
AL 56	25	31,25	M56 x 5,5	72	63	97	150	42	10,6	
AL 60	30	37,5	M60 x 5,5	72	63	97	150	42	10,8	
AL 64	36	45	M64 x 6	72	63	97	150	42	11	

Oogmoeren type EL

GRAAD 80

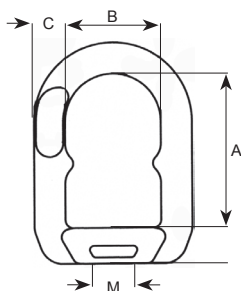

Ref.	Type	SWL(t)		Diam. ISO M/pas	A (mm)	B (mm)	C (mm)	D (mm)	Gewicht (kg)	Code art.
		Coef. 5	Coef. 4							
EL 6	5/6	0,2	0,25	M6 x 1	47	30	111	13	0,15	
EL 8	5/6	0,4	0,5	M8 x 1,25	47	30	11	13	0,15	
EL 10	5/6	0,7	0,875	M10 x 1,5	47	30	11	13	0,15	
EL 12	7/8	1	1,25	M12 x 1,75	51	32	12	13	0,25	
EL 14	7/8	1,2	1,5	M14 x 2	51	32	12	13	0,25	
EL 16	10	1,5	1,875	M16 x 2	64	37	14	15	0,4	
EL 18	10	2	2,5	M18 x 2,5	64	37	14	15	0,4	
EL 20	10	2,5	3,125	M20 x 2,5	64	37	14	15	0,4	
EL 22	13	3	3,75	M22 x 2,5	79	48	16	19	0,67	
EL 24	13	4	5	M24 x 3	79	48	16	19	0,67	
EL 27	13	5	6,25	M27 x 3	79	48	16	19	0,67	
EL 30	16	6	7,5	M30 x 3,5	90	57	21	24	1,2	
EL 33	16	7	8,75	M33 x 3,5	90	57	21	24	1,2	
EL 36	18/20	8	10	M36 x 4	100	66	24	42	1,5	
EL 39	18/20	9	11,25	M39 x 4	100	66	24	42	1,5	
EL 42	18/20	10	12,5	M42 x 4,5	100	66	24	2	1,5	
EL 45	22	15	18,75	M45 x 4,5	125	81	25	40	3	
EL 48	22	18	22,5	M48 x 5	125	81	25	40	3	

Lasringen type PAZ

GRAAD 80

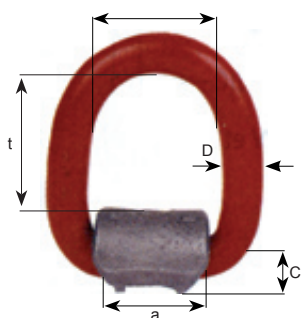

Ref.	SWL (Kg)	a (mm)	b (mm)	c (mm)	d (mm)	t (mm)	Gewicht (kg)	Code art.
PAZ G8 1,2	1200	35	40	28	13	42	0,4	
PAZ G8 3,2	3200	42	45	33	18	48,5	0,6	
PAZ G8 5,3	5300	49	55	44	22	57	1,2	
PAZ G8 8	8000	64	70	51	26	67	2,4	
PAZ G8 15	15000	86	97	65	34	93,5	5,9	

Oogbouten met gesmeed oog type S-279 en M279



S - 279 Draad UNC											
Ref.	Diam. (mm)	SWL (t)*	A draad** (mm)	B (mm)	C (mm)	D (mm)	E (mm)	F (mm)	G (mm)	Gewicht (Kg)	Code art.
9900182	6,35 x 25,4	0,29	1/4 - 20	25,9	28,7	19,1	58	4,85	13,5	0,02	
9900191	7,94 x 28,6	0,54	5/16 - 18	29,2	35,1	22,4	69,5	6,35	15	0,04	
9900208	9,53 x 31,8	0,7	3/8 - 16	32,3	41,1	25,4	78	7,85	17,5	0,06	
9900217	12,70 x 38,1	1,18	1/2 - 13	38,9	49,5	30,2	94	9,65	23,1	0,12	
9900226	15,90 x 44,5	2,35	5/8 - 11	45,5	60,5	35,1	113	12,7	28,7	0,24	
9900235	19,10 x 51,0	3,26	3/4 - 10	52	70	38,1	129	16	35,1	0,43	
9900244	22,20 x 57,0	4,08	7/8 - 9	58,5	82,5	44,5	149	19,1	39,6	0,7	
9900253	25,40 x 63,5	6,03	1 - 8	65,5	95,5	51	169	22,4	46	1,1	
9900262	31,80 x 76,0	9,52	1 - 1/4 - 7	78,5	114	63,5	202	25,4	58	1,8	
9900271	38,10 x 89,0	10,8	1 - 1/2 - 6	91,5	140	76	241	31,8	70	3,2	

* De breekkracht is gelijk aan 5 maal de SWL.
** Op aanvraag : speciale draad.

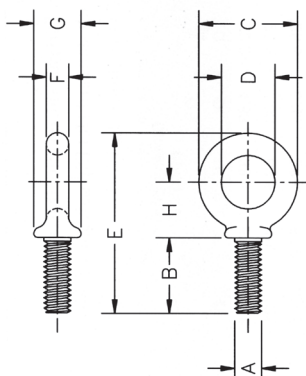

M - 279 Metrische draad											
Ref.	Diam. (mm)	SWL (t)*	A draad** (mm)	B (mm)	C (mm)	D (mm)	E (mm)	F (mm)	G (mm)	Gewicht (Kg)	Code art.
10457534	M 6	0,2	6	13	28,7	19,1	58	4,9	13,5	0,03	
10457894	M 8	0,4	8	13	35,1	22,4	59,7	6,4	15	0,05	
10458334	M 10	0,64	10	17	41,1	25,4	78	7,9	17,5	0,08	
10458694	M 12	1	12	20,5	49,5	30,2	94	9,7	23,1	0,18	
10459131	M 16	1,8	16	27	60,5	35,1	113	12,7	28,7	0,4	
10459954	M 20	2,5	20	30	70	38,1	129	16	35,1	0,9	
10460294	M 24	4	24	36	95,5	51	169	22,4	46	0,95	
10460754	M 30	6	30	45	114	53,5	202	25,4	58	1,6	
10461094	M 36	8,5	36	54	140	76	241	31,8	70	2,7	

* De breekkracht is gelijk aan 5 maal de SWL.
** Op aanvraag : speciale draad.

Bewegbare oogbouten

GRAAD 100

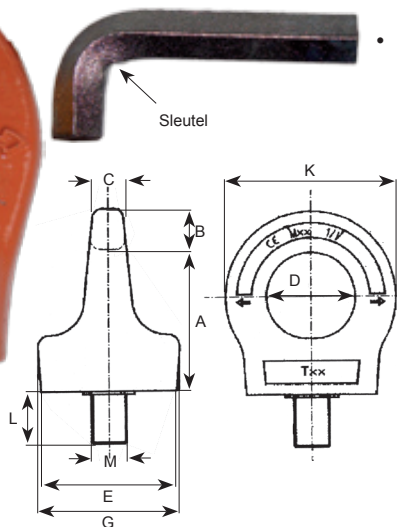

- Bewegbare oogbout **GRAAD 100**.
- Geleverd met sleutel om de bout te vijzen.

Diam. M	A (mm)	B (mm)	C (mm)	D (mm)	E (mm)	G (mm)	K (mm)	L (mm)
M8	52,5	12	8,5	25	32	34	49	15
M10	52,5	12	8,5	25	32	34	49	15
M12	62,4	14	8,5	30	44	46	58	18
M16	71,5	16	15	35	56	60	67	24
M20	79,9	18	17	40	58	60	76	30
M24	96,9	23	20	48	73	76	94	36
M30	123,9	27	28	60	80	84	114	45
M36	124,9	37	38	80	95	99	154	54
M42	148	40	41	90	105	114	170	63
M48	164,9	45	47	95	120	129	185	72

Ref.	Diam. M	SWL (t)								Code art.
		1 eind		2 einden		2 einden		3/4 einden		
		0°	0°	90°	90°	0-45°	45-60°	0-45°	45-60°	
C807XC08	M8	1	2	0,4	0,8	0,56	0,4	0,84	0,6	
C807XC10	M10	1	2	0,4	0,8	0,56	0,4	0,84	0,6	
C807XC12	M12	2	4	0,75	1,5	1	0,75	1,6	1,12	
C807XC16	M16	4	8	1,5	3	2	1,5	3,15	2,25	
C807XC20	M20	6	12	2,3	4,6	3,22	2,3	4,83	3,45	
C807XC24	M24	8	16	3,2	6,4	4,48	3,2	6,7	4,8	
C807XC30	M30	12	24	4,5	9	6,3	4,5	9,4	6,7	
C807XC36	M36	16	32	7	14	9,8	7	14,7	10,5	
C807XC42	M42	24	48	9	18	12,6	9	18,9	13,5	
C807XC48	M48	32	64	12	24	16,8	12	25,2	18	

Oogbouten HR125M met dubbele beweging



- Behouden hun SWL bij een hoek van 90°.
- Alle wisselstukken zijn vervaardigd in gelegeerd staal.
- Leverbaar zowel in metrische draad als in UNC draad.
- Kan 360° draaien en 180° kantelen.
- Hebben een veiligheidscoëfficiënt 5 bij een cyclus van 20000.
- De bouten kunnen met verschillende lengtes bekomen worden.
- Op elke ring kunt u het volgende lezen: SWL en aandraaimoment.
- Enkel te gebruiken met ijzerproducten.

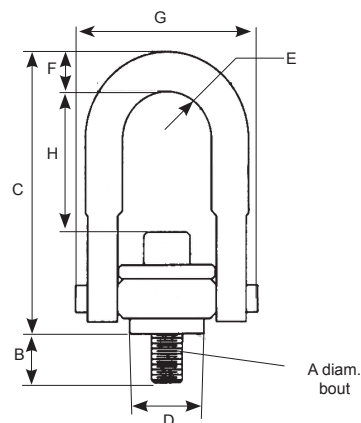

Ref.	SWL (t)		Moment (Nm)	A (mm)	B (mm)	C (mm)	D (mm)	E (mm)	F (mm)	G (mm)	H (mm)	Gewicht (Kg)	Code art.
	Veiligheids-coef 5:1	Veiligheids-coef 4:1											
1016602	0,4	0,5	10	M 8 x 1,25 x 40	16,9	68,1	25,4	11,8	8,5	42,9	28,2	0,19	
1016613	0,45	0,55	16	M10 x 1,50 x 40	16,9	68,1	25,4	11,8	8,5	42,9	27,69	0,19	
1016624	1,05	1,3	38	M12 x 1,75 x 50	17,2	124,5	50,8	22,3	17,5	82,7	58,17	1,13	
1016635	1,9	2,4	81	M16 x 2,0 x 60	27,2	124,5	50,8	22,3	17,5	82,7	56,13	1,22	
1016644	2,15	2,7	136	M20 x 2,50 x 65	31,2	124,5	50,8	22,3	7,5	82,7	52,07	1,36	
1016657	3	3,75	136	M20 x 2,50 x 75	28,1	167	76,2	34,7	25,4	120,1	75,69	3,18	
1016668	4,2	5,25	312	M24 x 3,00 x 80	33,1	167	76,2	34,7	25,4	120,1	74,93	3,18	
1016679	7	8,75	637	M30 x 3,5 x 120	65,1	231,5	95,3	44,5	31,8	152,4	63,34	6,7	
1016690	11	13,75	1005	M36 x 4,0 x 150	60,6	315,3	120,7	57,2	44,5	203,2	124,2	14,95	
1016701	12,5	15,6	1005	M42 x 4,5 x 160	70,6	315,3	120,7	57,2	44,5	203,2	150,62	16,33	
1016712	13,5	16,9	1350	M48 x 5,0 x 160	70,6	315,3	120,7	57,2	44,5	203,2	137,92	16,33	

Oogbouten HR1000M met dubbele beweging

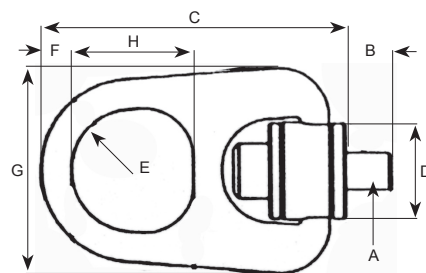

SWL (t)	Moment (Nm)	A (mm)	B (mm)	C (mm)	D (mm)	E (mm)	F (mm)	G (mm)	H (mm)	Gewicht (Kg)	Code art.
0,5	10	M8 x 1,25 x 40	15	94	25	16	11	58	35	0,28	
0,55	16	M10 x 1,5 x 40	15	94	25	16	11	58	35	0,29	
1,3	38	M12 x 1,5 x 55	16	162	50	32	19	107	64	1,38	
2,4	81	M16 x 2,0 x 65	26	162	50	32	19	107	64	1,42	
2,7	136	M20 x 2,5 x 70	31	162	50	32	19	107	64	1,5	
3,75	136	M20 x 2,5 x 80	25	220	75	41	25	159	83	4,61	
5,25	312	M24 x 3,0 x 90	35	220	75	41	25	159	83	4,72	
5,25	312	M30 x 3,5 x 100	35	220	75	41	25	159	83	4,85	
8,75	637	M30 x 3,5 x 140	66	285	94	51	32	199	102	9,89	
13,75	1005	M36 x 4,0 x 130	56	285	94	51	32	199	102	10,2	

Oogbouten met enkele beweging type ALA

GRAAD 80

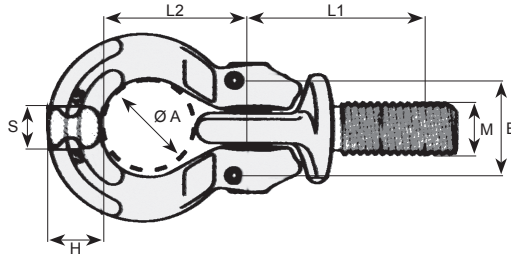

Ref.	SWL (t)		A (mm)	C (mm)	E (mm)	H (mm)	L1 (mm)	L2 (mm)	Gewicht (Kg)	Code art.
	0°	90°								
ALA 6M6	0,25	0,13	18	20	25	11	15	30	0,1	
ALA 6M8	0,5	0,25	18	20	25	11	15	30	0,1	
ALA 6M10	0,87	0,43	18	20	25	11	15	30	0,1	
ALA 8M12	1,25	0,63	22	35	34	16	19	38	0,27	
ALA 8M14	1,5	0,75	22	35	34	16	19	38	0,27	
ALA 8M16	1,87	0,93	22	35	34	16	19	38	0,27	
ALA 8M18	2,5	1,25	28	45	40	16	23	46	0,4	
ALA 10M20	3,12	1,56	28	45	40	16	23	46	0,4	
ALA 13M22	3,75	1,88	38	52	54	21	30	62	1	
ALA 13M24	5	2,5	38	52	54	21	30	62	1	
ALA 16M27	6,25	3,13	46	70	66	28,5	35	72	1,7	
ALA 16M30	7,5	3,75	46	70	66	28,5	35	72	1,7	
ALA 16M33	8,75	4,38	46	70	66	28,5	35	72	1,7	

Oogbouten met dubbele beweging type ADA

GRAAD 80 en GRAAD 100



- Draait 360° en kantelt op 180°.
- Behoudt 100% SWL bij een hoek van 90°.
- Leverbaar in graad 80 of graad 100.

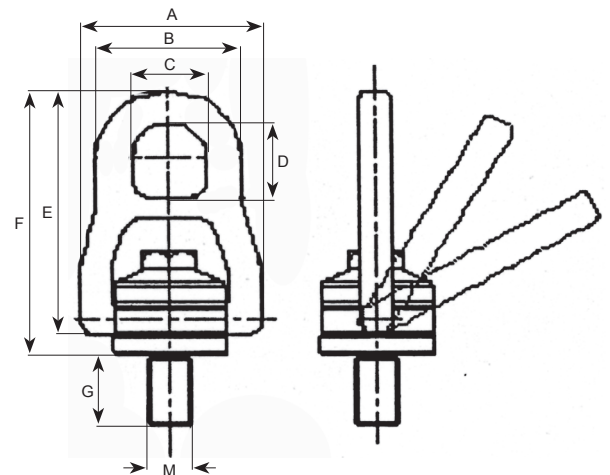

Graad 80			Graad 100			M	A (mm)	B (mm)	C (mm)	D (mm)	E (mm)	F (mm)	G (mm)	Code art.
Ref.	SWL (t)		Ref.	SWL (t)										
	0°	90°		0°	90°									
ADA M8	0,3	0,3	ADA M8 X	0,375	0,375	M8	62	45	24	29	78	85	14,5	
ADA M10	0,6	0,6	ADA M10 X	0,75	0,75	M10	62	45	24	29	78	85	24,5	
ADA M12	1,2	1,2	ADA M12 X	1,5	1,5	M12	62	45	24	29	78	85	24,5	
ADA M16	2	2	ADA M16 X	2,5	2,5	M16	72	58	29	32	89	96	32,5	
ADA M20	3,2	3,2	ADA M20 X	4	4	M20	82	65	33	38	105	114	33	
ADA M24	5,4	5,4	ADA M24 X	6,25	6,25	M24	97	76	38	48	129	139	40	
ADA M30	8	8	ADA M30 X	10	10	M30	123	90	48	58	155	166	50	



Deze haak is ideaal om hoge prefab-elementen op een vrachtwagen te laden. Dankzij deze zelf openende haak hoeft niemand op een ladder te klimmen om de haak los te maken. Zo vermijdt u een gevaarlijke handeling.

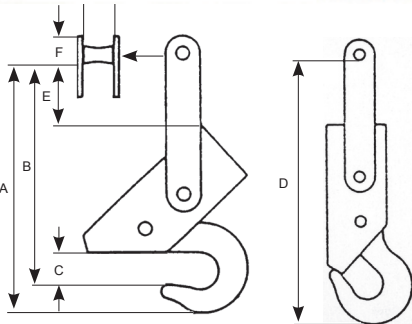

Ref.	SWL (t)	A (mm)	B (mm)	C (mm)	D (mm)	E (mm)	F (mm)	G (mm)	Gewicht (kg)	Code art.
IS 2	2	310	280	60	340	80	20	42	3	
IS 5	5	360	325	50	430	90	32	54	6,7	
IS 10	10	490	425	65	580	110	44	58	15	
IS 15	15	525	460	80	625	115	54	72	24	
IS 20	20	580	500	80	700	130	65	83	37	

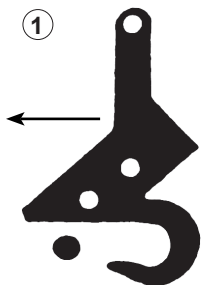

1 Inhaken

Zonder last staat de haak open om een last te tillen.



2 Hijzen

Het gewicht van de last zorgt er voor dat de haak gesloten wordt.

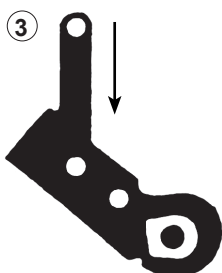

3 Neerleggen

Eens de last neergelaten blijft de haak gesloten tot men hem genoeg laat zakken.

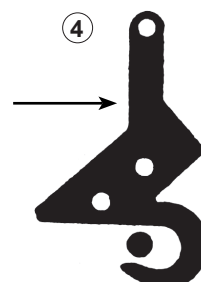

4 Openen

Pas als er een hoek van 60° bereikt is gaat de haak open.

Haken voor wapeningsnetten

Type CTS



- Dit systeem is één van de weinigen dat de veiligheid introduceert in het hijsen van wapeningsnetten. Het bestaat uit 4 speciale haken die aan een hefbalk of kettingviersprong moeten worden vastgemaakt.
- Dankzij spiraalveren voorkomt men dat de haken zouden lossen. Deze veren zijn beschermd door een pvc buis opdat men zijn vingers niet zou kwetsen. De haken die 3.4kg wegen plaatst men vervolgens in mazen van het net.
- De SWL bedraagt 1200kg per haak of 3000kg voor de 4 samen bij een hoek van 90°.
- Ze zijn gepatenteerd klasse EG 6-8.
- Gewicht 2,3 kg.

De veilige behandeling van gelaste wapeningsnetten

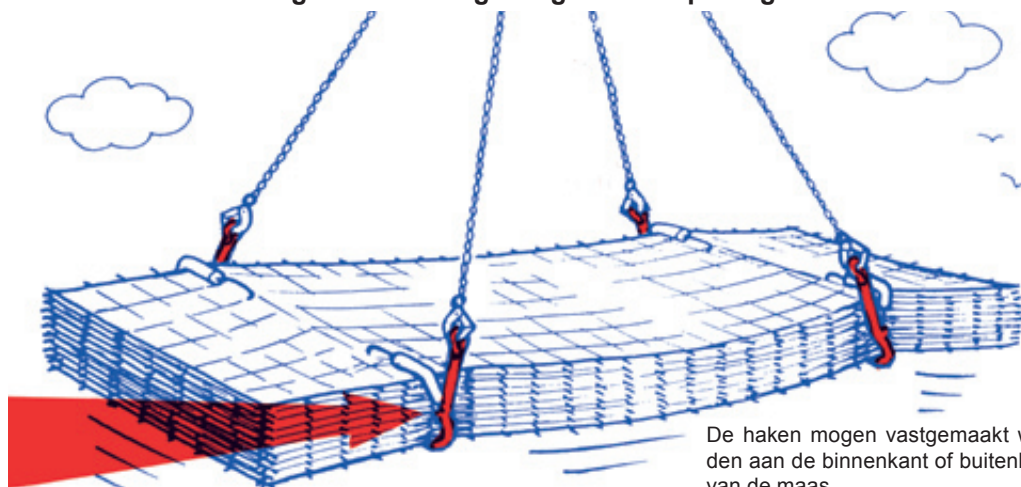

De haken mogen vastgemaakt worden aan de binnenkant of buitenkant van de maas.

Elke haak wordt eerst horizontaal tussen de lasten ingevoerd. Wanneer de last op een hard oppervlakte (bijvoorbeeld de plaat van een vrachtwagen) wordt geplaatst, kan het nuttig zijn om te heffen met behulp van een speciaal werktuig, «hanteersleutel» genoemd.

Vervolgens laat men de haak een kwart draaien in verticale positie, wat tot gevolg heeft dat de punt in de maas wordt ingebracht. De veiligheid is dan ingeschakeld.

Verboden te gebruiken zonder veiligheidssysteem



Het beveiligingssysteem tegen het losraken van de netten moet verplicht aan de buitenzijde van de lengen worden aangebracht.



Nieuwe vorm die het mogelijk maakt om 2 wapeningsnetten te scheiden teneinde er gemakkelijker de haak in te steken.

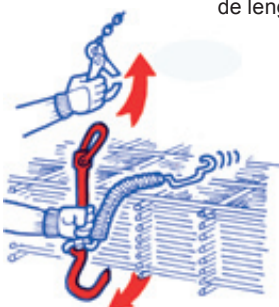

Nooit het veiligheidssysteem laten slepen.



Altijd het veiligheidssysteem aan de haak bevestigen.

Wartels

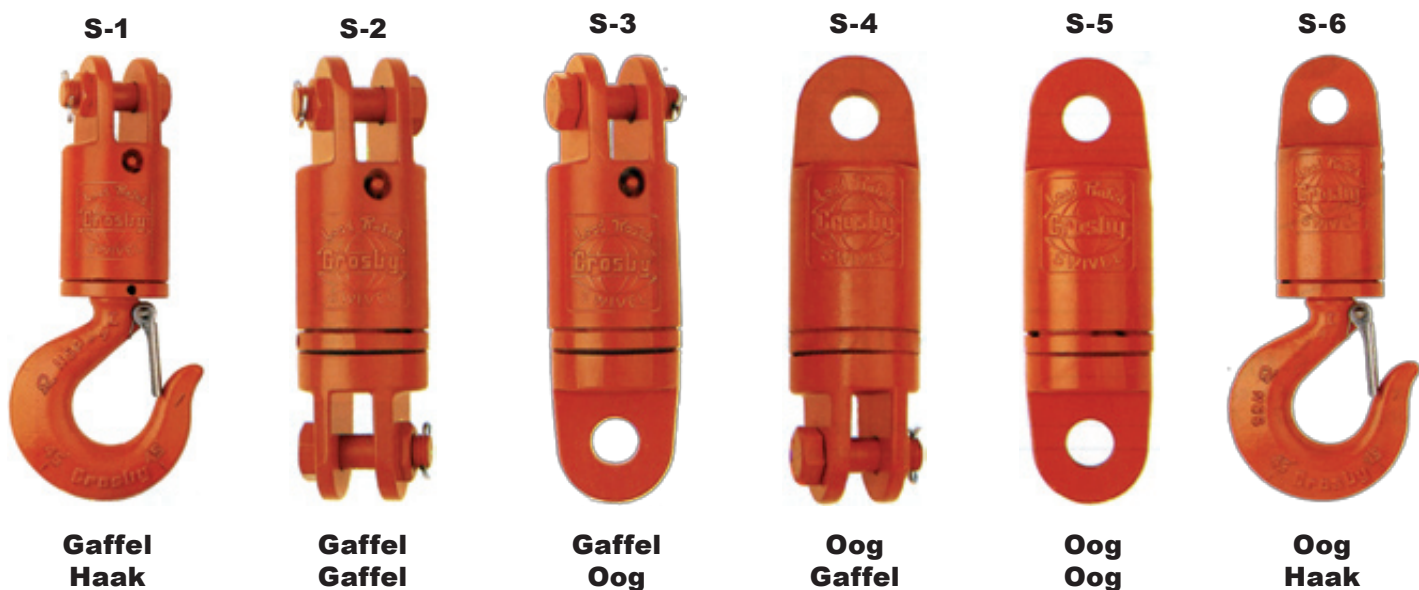

- Gemaakt om onder belasting te draaien.
- Ze worden allemaal geleverd met attest.
- Mogen niet gebruikt worden met sloopbollen.
- Andere types en krachten beschikbaar tot 600 ton.
- Alle haken zijn voorzien van kleppen.

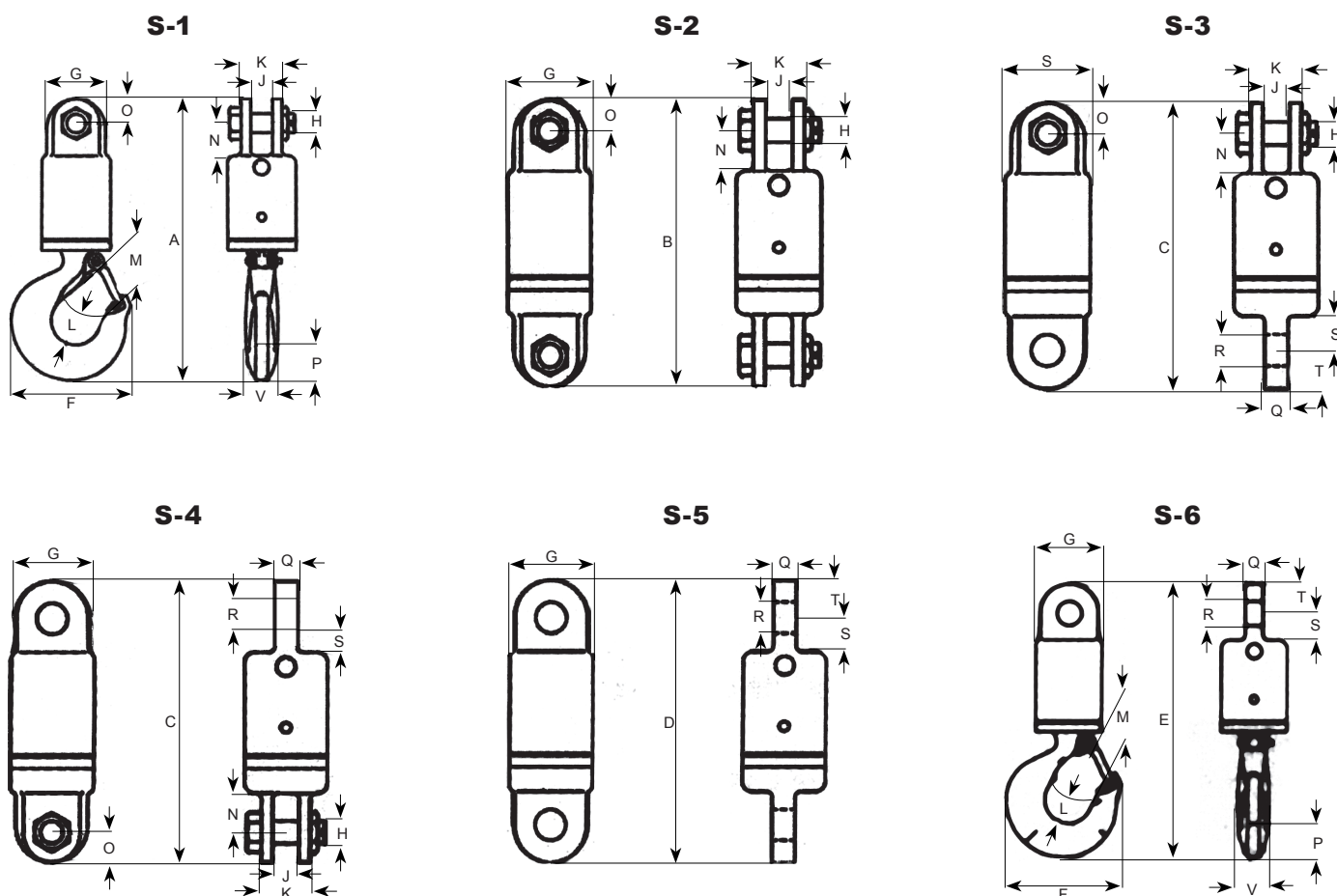

S-1 Gaffel en Haak

Ref.	Type	SWL (t)	Diam. kabel (mm)	A (mm)	F (mm)	G (mm)	H (mm)	J (mm)	K (mm)	L (mm)	M (mm)	N (mm)	O (mm)	P (mm)	V (mm)	Gewicht (Kg)	Code art.
297011	3 S-1	3	13	291	123	70	19,1	22,4	41,1	38,9	35,8	33,3	25,4	36,6	28,4	4,45	
297217	5 S-1	5	16	339	160	76	22,4	25,4	57	49,3	42,9	41,1	28,4	46	36,6	7,04	
297413	8 S-1	8-1/2	19	418	192	102	25,4	39,5	71,5	62,5	56,5	54	35,1	57	41,1	13,3	
297618	10 S-1	10	22	502	212	114	38,1	44,5	86	66	61	89	44,5	66	49,3	21,2	
297814	15 S-1	15	26	565	263	127	38,1	44,5	86	71,5	81	89	44,5	76	60,5	33,5	
298118	25 S-1	25	-	680	346	152	51	51	117	87,5	92	93,5	60,5	93	76	64	
298216	35 S-1	35	-	760	357	165	51	51	117	98,5	95,5	93,5	60,5	116	81	100	
298314	45 S-1	45	-	891	392	178	57	63,5	127	121	108	102	76	129	82,5	114	

S-2 Gaffel en Gaffel

Ref.	Type	SWL (t)	Diam. kabel (mm)	B (mm)	G (mm)	H (mm)	J (mm)	K (mm)	N (mm)	O (mm)	Gewicht (Kg)	Code art.
297020	3 S-2	3	13	236	70	19,1	22,4	41,1	33,3	25,4	4,37	
297226	5 S-2	5	16	262	76	22,4	25,4	57	41,1	28,4	6,21	
297422	8 S-2	8-1/2	19	321	102	25,4	39,5	71,5	54	35,1	11,9	
297627	10 S-2	10	22	426	114	38,1	44,5	86	89	44,5	20,8	
297823	15 S-2	15	26	435	127	38,1	44,5	96	89	44,5	28,5	
298127	25 S-2	25	-	527	152	51	51	117	93,5	60,5	64	
298225	35 S-2	35	-	527	165	51	51	117	93,5	60,5	70	
298323	45 S-2	45	-	641	178	57	63,5	127	102	76	107	

S-3 Gaffel en Oog

Ref.	Type	SWL (t)	Diam. kabel (mm)	C (mm)	G (mm)	H (mm)	J (mm)	K (mm)	N (mm)	O (mm)	Q (mm)	R (mm)	S (mm)	T (mm)	Gewicht (kg)	Code art.
297039	3 S-3	3	13	237	70	19,1	22,4	41	33,3	25,4	19,1	26,2	28,4	31,8	4,14	
297235	5 S-3	5	16	256	76	22,4	25,4	57	41,1	28,4	25,4	32,5	31,8	31,8	6,12	
297431	8 S-3	8-1/2	19	311	102	25,4	39,5	71,5	54	35,1	31,8	35,8	41,1	38,1	11,3	
297636	10 S-3	10	22	409	114	38,1	44,5	86	89	44,5	42,9	42,9	70	47,8	19,7	
297832	15 S-3	15	26	425	127	38,1	44,5	86	89	44,5	49,3	51,5	70	54	27,7	
298136	25 S-3	25	-	546	152	51	51	117	93,5	60,5	57	58,5	98,5	60,5	61	
298234	35 S-3	35	-	546	165	51	51	117	93,5	60,5	57	58,5	98,5	60,5	68	
298332	45 S-3	45	-	657	178	63,5	63,5	127	102	76	63,5	64,5	102	76	102	

S-4 Oog en Gaffel

Ref.	Type	SWL (t)	Diam. kabel (mm)	C (mm)	G (mm)	H (mm)	J (mm)	K (mm)	N (mm)	O (mm)	Q (mm)	R (mm)	S (mm)	T (mm)	Gewicht (kg)	Code art.
297048	3 S-4	3	13	237	70	19,1	22,4	41	33,3	25,4	19,1	26,2	28,4	31,8	4,14	
297244	5 S-4	5	16	256	76	22,4	25,4	57	41,1	28,4	25,4	32,5	31,8	31,8	6,12	
297440	8 S-4	8-1/2	19	311	102	25,4	39,5	71,5	54	35,1	31,8	35,8	41,1	38,1	11,3	
297645	10 S-4	10	22	409	114	38,1	44,5	86	89	44,5	42,9	42,9	70	47,8	19,7	
297841	15 S-4	15	26	425	127	38,1	44,5	86	89	44,5	49,3	51,5	70	54	27,7	
298145	25 S-4	25	-	546	152	51	51	117	93,5	60,5	57	58,5	98,5	60,5	61	
298243	35 S-4	35	-	546	165	51	51	117	93,5	60,5	57	58,5	98,5	60,5	68	
298341	45 S-4	45	-	657	178	63,5	63,5	127	102	76	63,5	64,5	102	76	102	

S-5 Oog en Oog

Ref.	Type	SWL (t)	Diam. kabel (mm)	D (mm)	G (mm)	Q (mm)	R (mm)	S (mm)	T (mm)	Gewicht (kg)	Code art.
297057	3 S-5	3	13	239	70	19,1	26,2	28,4	31,8	3,86	
297253	5 S-5	5	16	249	76	25,4	32,5	31,8	31,8	5,13	
297459	8 S-5	8-1/2	19	302	102	31,8	35,8	41,1	38,1	13,3	
297654	10 S-5	10	22	394	114	42,9	42,9	70	47,8	19,1	
297850	15 S-5	15	26	416	127	49,3	51,5	70	54	22,2	
298154	25 S-5	25	-	565	152	57	58,5	98,5	60,5	59	
298252	35 S-5	35	-	565	165	57	58,5	98,5	60,5	66	
298350	45 S-5	45	-	673	178	63,5	64,5	102	76	98	

S-6 Oog en Haak

Ref.	Type	SWL (t)	Diam. kabel (mm)	E (mm)	F (mm)	G (mm)	L (mm)	M (mm)	P (mm)	Q (mm)	R (mm)	S (mm)	T (mm)	V (mm)	Gewicht (kg)	Code art.
297066	3 S-6	3	13	292	123	70	38,9	35,8	36,6	19,1	26,2	28,4	31,8	28,4	4,23	
297262	5 S-6	5	16	332	160	76	49,3	42,9	46	25,4	32,5	31,8	31,8	36,6	6,46	
297468	8 S-6	8-1/2	19	408	192	102	62,5	56,5	57	31,8	35,8	41,1	38,1	41,1	14,5	
297663	10 S-6	10	22	486	212	114	66	61	66	42,9	42,9	70	47,8	49,3	20,6	
297869	15 S-6	15	26	540	263	127	71,5	81	76	51,5	51,5	70	54	60,5	28,6	
298163	25 S-6	25	-	699	346	152	87,5	92	93	58,5	58,5	98,5	60,5	76	61	
298261	35 S-6	35	-	780	357	165	98,5	95,5	116	58,5	58,5	98,5	60,5	81	98	
298369	45 S-6	45	-	907	392	178	121	108	129	64,5	64,5	102	76	82,5	122	

Praktische inlichtingen

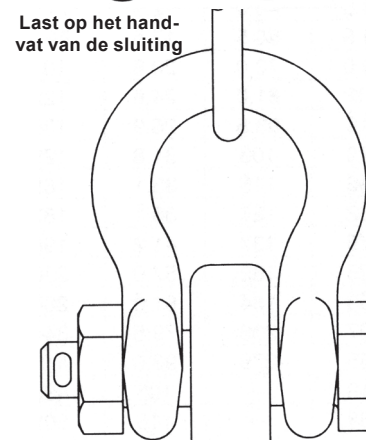
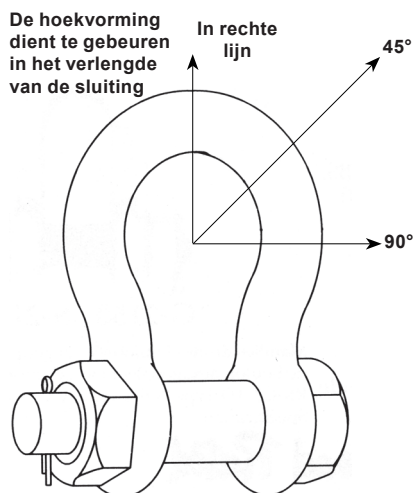

De last mag zowel door de as als door het lichaam van de sluiting gedragen worden. De last dient wel in het midden van de as geplaatst te worden.

Hoek van de zijdelinkse belasting	SWL aangepast aan de hoek
0° in rechte lijn	100% van de SWL
45° van de verticale as	70% van de SWL
90° van de verticale as	50% van de SWL

De sluitingen met as en splipen (zonder moer) mogen geen zijdelingse krachten dragen.

Nooit de 120° overschrijden.
Enkel de sluitingen borst/
bout of moer/bout gebruiken.

De SWL van de sluitingen hoeft
geen rekening te houden met
de gevormde hoek zolang deze
de 120° niet overschrijdt.

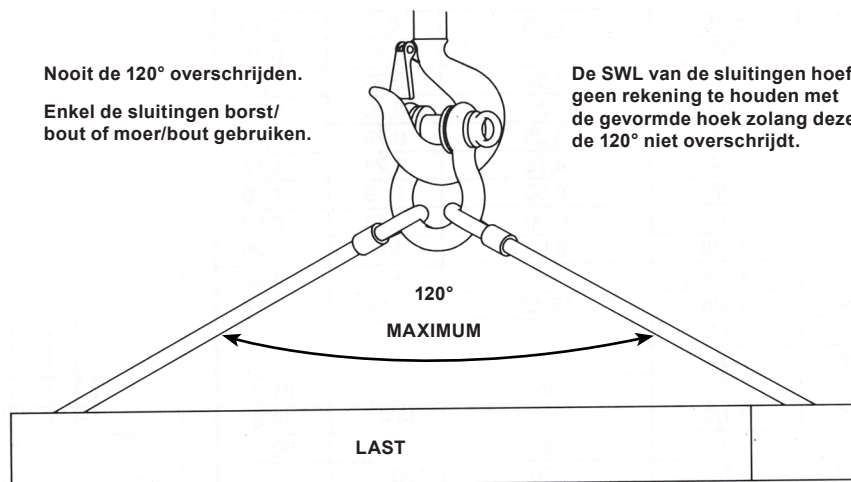

SWL voor sluitingen van 85t en meer

Het beste geval is dat waar het te hijsen oog 80% van de as-breedte beslaat. Indien het niet het geval is gelden de volgende regels:

1°/ Het hijs oog beslaat **60%** van de as-breedte :

$$SWL = 0.87 \times SWL \text{ sluiting}$$

2°/ Het hijs oog beslaat **40%** van de as-breedte :

$$SWL = 0.80 \times SWL \text{ sluiting}$$

3°/ Het hijs oog is nog smaller :

$$SWL = 0.7 \times SWL \text{ sluiting}$$

Nominaal SWL van synthetische lengen

Het plooiën, samendrukken of pitsen van synthetische lengen door sluitingen, haken, ed.

Lussen vormen



De as moet in het oog van de leng geplaatst worden.



Samendrukken

Pitsen

Rechte «D» sluiting borst/bout

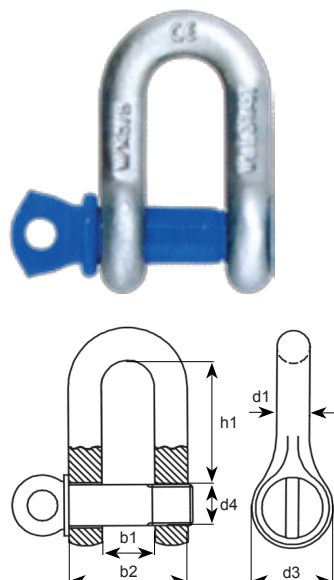

Ref.	SWL (t)	INCH	b1 (mm)	b2 (mm)	d1 (mm)	d4 (mm)	h1 (mm)	d3 (mm)	Gewicht 100 st (kg)	Code art.
210 A	0,5	1/4	12	26	6	8	22	17	5	
210 B	0,75	5/16	13	29	8	10	26	21	8	
210 C	1	3/8	16	36	10	12	31	26	13	
210 D	1,5	7/16	18	40	11	14	36	28	19	
210 E	2	1/2	21	47	13	16	41	30	31	
210 F	3,25	5/8	27	59	16	20	51	42	55	
210 G	4,75	3/4	32	70	19	22	60	48	96	
210 H	6,5	7/8	36	80	22	27	71	57	141	
210 J	8,5	1	43	93	25	28	81	62	203	
210 K	9,5	1 1/8	46	104	29	33	90	69	297	
210 L	12	1 1/4	52	116	32	36	100	78	401	
210 M	13,5	1 3/8	57	127	35	39	113	86	540	
210 N	17	1 1/2	60	136	38	42	124	94	729	
210 P	25	1 3/4	73	161	44	52	146	112	1125	
210 R	35	2	83	185	51	60	171	135	1620	
210 S	55	2 1/2	106	232	63	72	203	158	3330	

Type 210

Veiligheidscoëfficiënt 6

Harp sluitingen borst/bout

Type 209

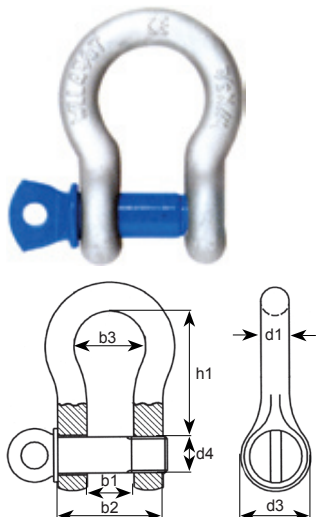

Ref.	SWL (t)	INCH	b1 (mm)	b2 (mm)	b3 (mm)	d1 (mm)	d3 (mm)	d4 (mm)	h1 (mm)	Gewicht 100 st (kg)	Code art.
209 Z	0,33	3/16	9,7		15,2	4,83	14,2	6,35	22,4	2	
209 A	0,5	1/4	12	25	19	6	17	8	28	5	
209 B	0,75	5/16	13	29	21	8	21	10	31	8	
209 C	1	3/8	16	36	26	10	26	12	36	314	
209 D	1,5	7/16	18	40	29	11	28	14	42	22	
209 E	2	1/2	21	47	33	13	30	16	48	33	
209 F	3,25	5/8	27	59	43	16	42	20	60	65	
209 G	4,75	3/4	32	70	51	19	48	22	71	97	
209 H	6,5	7/8	36	80	58	22	57	27	84	146	
209 J	8,5	1	43	93	68	25	62	28	95	239	
209 K	9,5	1 1/8	46	104	74	29	69	33	103	315	
209 L	12	1 1/4	52	116	82	32	78	36	119	432	
209 M	13,5	1 3/8	57	127	92	35	86	39	133	567	
209 N	17	1 1/2	60	136	98	38	94	42	146	779	
209 P	25	1 3/4	73	161	127	44	112	52	178	12511	
209 R	35	2	83	185	146	51	135	60	197	11850	
209 S	55	2 1/2	106	232	184	63	158	72	267	3758	

Rechte "D" sluitingen moer/bout

Type 2150

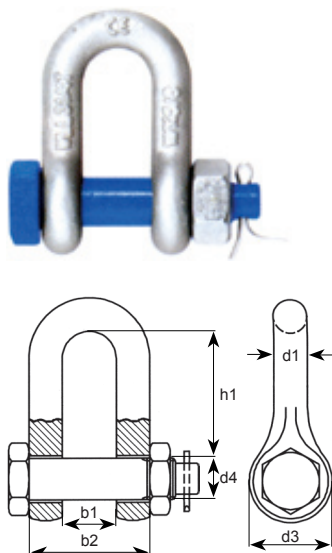

Ref.	SWL (t)	INCH	b1 (mm)	b2 (mm)	d1 (mm)	d4 (mm)	h1 (mm)	d3 (mm)	Gewicht 100 st (kg)	Code art.
2150 A	0,5	1/4	12	26	6	8	22	17	6	
2150 B	0,75	5/16	13	29	8	10	26	21	10	
2150 C	1	3/8	16	36	10	12	31	26	15	
2150 D	1,5	7/16	18	40	11	14	36	28	22	
2150 E	2	1/2	21	47	13	16	41	30	34	
2150 F	3,25	5/8	27	59	16	19	51	42	70	
2150 G	4,75	3/4	32	70	19	22	60	48	118	
2150 H	6,5	7/8	36	80	22	25	71	57	164	
2150 J	8,5	1	43	93	25	28	81	62	241	
2150 K	9,5	1 1/8	46	104	29	32	90	69	327	
2150 L	12	1 1/4	52	116	32	35	100	78	459	
2150 M	13,5	1 3/8	57	127	35	38	113	86	600	
2150 N	17	1 1/2	60	136	38	42	124	94	833	
2150 P	25	1 3/4	73	161	44	50	146	112	1283	
2150 R	35	2	83	185	51	55	171	127	1930	
2150 S	55	2 1/2	105	232	64	70	203	151	3450	
2150 T	85	3	127	279	76	82	216	200	6000	
2150 U	120	3 1/2	133	317	89	95	253	203	9300	
2150 V	150	4	140	348	102	107	250	226	14500	

Harp sluitingen moer/bout

Type 2130

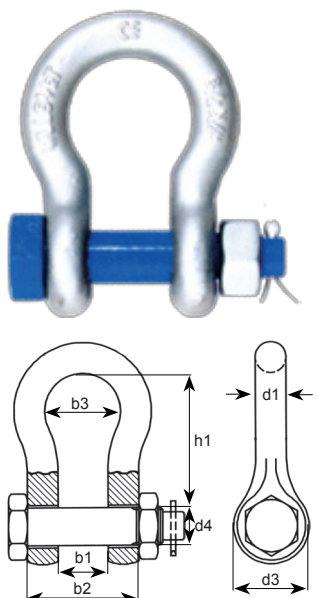

Ref.	SWL (t)	INCH	b1 (mm)	b2 (mm)	b3 (mm)	d1 (mm)	d3 (mm)	d4 (mm)	h1 (mm)	Gewicht 100 st (kg)	Code art.
2130 A	0,5	1/4	12	25	19	6	17	8	28	7	
2130 B	0,75	5/16	13	29	21	8	21	10	31	10	
2130 C	1	3/8	16	36	26	10	26	12	36	18	
2130 D	1,5	7/16	18	40	29	11	28	14	42	25	
2130 E	2	1/2	21	47	33	13	30	16	48	37	
2130 F	3,2	5/8	27	59	43	16	42	20	60	71	
2130 G	4,7	3/4	32	70	51	19	48	22	71	127	
2130 H	6,5	7/8	36	80	58	22	57	27	84	178	
2130 J	8,5	1	43	93	68	25	62	28	95	252	
2130 K	9,5	1 1/8	46	104	74	29	69	33	109	353	
2130 L	12	1 1/4	52	116	82	32	78	36	119	504	
2130 M	13,5	1 3/8	57	127	92	35	86	39	133	684	
2130 N	17	1 1/2	60	136	98	38	94	42	146	878	
2130 P	25	1 3/4	73	161	127	44	112	52	178	1409	
2130 R	35	2	83	185	146	51	127	55	197	2090	
2130 S	55	2 1/2	105	232	184	64	152	70	267	3990	
2130 T	85	3	127	279	200	76	200	82	330	6200	
2130 U	120	3 1/2	137	321	232	92	220	95	374	10900	
2130 V	150	4	145	353	250	104	240	108	372	13000	

Veiligheidscoëfficiënt 6

Kruiwagenketting 3 einden verzinkt

- Ref. BL-CII.
- Diam. ketting : 6 mm.
- SWL 60° : 250 kg en SWL 45° : 350 kg.



1 haak

Voldoet aan de huidige geldende EU-richtlijn 98/37/EG.
Voldoet aan de geharmoniseerde normen EN 10204 3.1 B en EN 818.

Ketting lange schakels Din 763

staal St-35

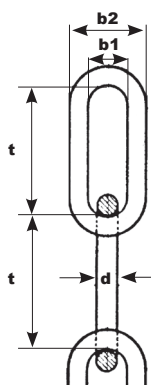

RVS zie blz. 217

Ref.	Diam. (mm)	SWL (Kg)	Breukkracht (Kg)	t (mm)	b1 (mm)	b2 (mm)	Gewicht (kg/m)	Code art.
763A	4	100	600	32	8	16	0,27	
763B	5	160	980	35	10	20	0,43	
763C	6	200	1250	42	12	24	0,63	
763D	7	300	1800	49	14	28	0,86	
763E	8	400	2500	52	16	32	1,1	
763G	10	630	4000	65	20	40	1,75	
763K	13	1000	6300	82	26	52	2,95	
763M	16	1600	9810	100	32	64	4,45	

Afwerking : blank of verzinkt

Deze ketting mag niet gebruikt worden om te hijsen

Ketting korte schakels Din 766

staal St-35

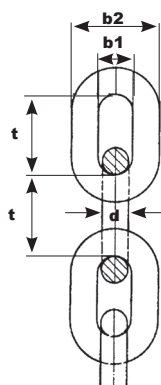

RVS zie blz. 213

Ref.	Diam. (mm)	SWL (Kg)	Breukkracht (Kg)	t (mm)	b1 (mm)	b2 (mm)	Gewicht (kg/m)	Code art.
766A	4	150	600	16	6	14	0,32	
766B	5	250	1000	18,5	7	17	0,5	
766C	6	350	1400	18,5	8	20	0,75	
766D	7	450	1800	22	9	23	1	
766E	8	630	2520	24	10	26	1,35	
766F	9	800	3200	26	12	30	1,8	
766G	10	1000	4000	28	14	34	2,25	
766H	11	1120	4480	31	14	36	2,7	
766K	13	1600	6400	36	18	44	3,8	
766M	16	2500	10000	45	22	54	5,8	
766N	18	3150	12600	50	24	60	7,3	
766P	20	4000	16000	56	27	67	9	

Afwerking : blank of verzinkt

Deze ketting mag niet gebruikt worden om te hijsen

Gekalibreerde takelketting

Type 720/721

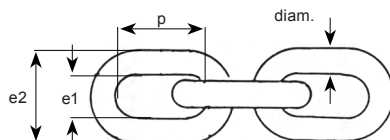

Volgens DIN 5684-8 - Klasse 80

Ref.	Diam. (mm)	P (mm)	e1 mini binnen (mm)	e2 maxi buiten (mm)	Breukkracht (kg)	Code art.
720 040	4	12	5	13,7	2000	
720 050	5	15	6	16,9	3150	
720 060	6	18	7,2	20,2	4500	
720 070	7	21	8,4	23,6	6000	
720 080	8	24	9,6	27	8000	
720 090	9	27	10,8	30,4	10000	
720 100	10	28	12	34	12500	
720 110	11	31	13,2	37,4	15000	
720 130	13	36	15,6	44,2	21200	
720 160	16	45	19,2	54,4	31500	

Volgens ISO 3077 - Klasse 80

Ref.	Diam. (mm)	P (mm)	e2 mini binnen (mm)	e2 maxi buiten (mm)	Breukkracht (kg)	Code art.
721 040	4	12	13	13,3	20,2	
721 050	5	15	17	17,38	31,6	
721 056	5,6	17	19	19,42	39,6	
721 063	6,3	19	21	21,48	50	
721 071	7,1	21	23	23,54	53,4	
721 080	8	24	26	26,5	80,6	
721 090	9	27	30	30,68	102	
721 100	10	30	33	33,75	126	

Minimum breukkracht : 80 kg/mm²

Verpakking : Bundels van 100m in vaten of op paletten – andere lengtes op aanvraag.

Standaard : Gepolijst

Gekalibreerde handketting voor takels

Type 901

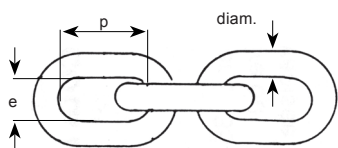

Gelast

Ref. Blank	Ref. Verzink	Diam. (mm)	Binnen afmetingen		Gewicht (kg/m)	Code art.
			p (mm)	e mini (mm)		
901 001	901 001	5	17,5	7	0,51	
901 002	901 002	5	23,7	7,3	0,45	
901 003	901 003	5	24	8,2	0,45	
901 004	901 004	5	25	8	0,45	
901 005	901 005	5	5,2	7,8	0,45	
9010 06	9010 06	5	26,8	10	0,44	
901 007	901 007	5	27,4	7,8	0,44	
901 008	9010 08	5,5	18,7	7,2	0,6	
901 009	901 009	6	18	7,4	0,8	
901 010	901 010	6	18,2	7,4	0,8	
901 011	901 011	6	26,3	9,7	0,67	
901 012	901 012	6	26,5	9,5	0,67	
901 013	901 013	6	26,7	9,2	0,67	
901 014	901 014	6	27,7	7,2	0,64	
901 015	901 015	6	27,8	9,2	0,64	

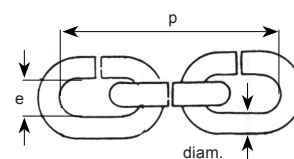

Ongelast

Ref. Blank	Ref. Verzink	Diam. (mm)	Binnen afmetingen		Gewicht (kg/m)	Code art.
			p (mm)	e mini (mm)		
901 020	902 020	6	18,3	8	0,78	
901 021	902 021	7	26,6	9,5	0,91	
901 022	902 022	7	27,5	9,5	0,9	

De handkettingen mogen in geen geval gebruikt worden om te hijsen.

Verpakking :

Bundels van 100m in vaten of op paletten – andere lengtes op aanvraag.

Nestenschijven

gietijzer FT 25

Voor ketting volgens de Norm NFE 26011

Ref.	Diam. ketting (mm)	Aantal nesten	Diam. binnen (mm)	Buiten diam. D (mm)	Breedte E (mm)	Code art.
380 008	8	6	92	110	55	
380 010	10	6	115	133	65	
380 012	12	6	138	166	80	
380 014	14	5	135	165	85	
380 016	16	5	155	185	100	

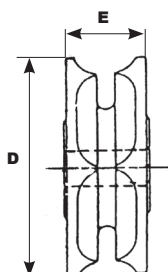

Voor ketting volgens de Norm NFE 26012

Ref.	Diam. ketting (mm)	Aantal nesten	Diam. binnen (mm)	Buiten diam. D (mm)	Breedte E (mm)	Code art.
381 010	10	6	134	162	75	
381 016	16	5	180	225	110	

Aandrijfkettingen AT – klasse 80

Type 850/860

De kettingen NFE 26011 en NFE 26012 zijn vervaardigd in hoogwaardig staal en zijn onderworpen aan een speciale thermische behandeling die hen een grote slijtvastheid bezorgt.

Deze kettingen worden veel gebruikt in de landbouw.

Stap 3 x d Norm NFE 26001

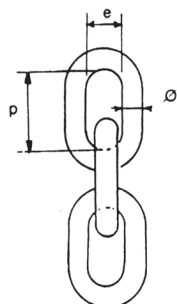

Ref.	Diam. ketting (mm)	Buiten afmetingen (mm)		Breukkracht (t)	Gewicht (kg/m)	Code art.
		P	e mini			
850 080	8	24	10,4	8	1,39	
850 100	10	30	13	12,5	2,17	
850 120	12	36	15,6	18	3,12	
850 140	14	42	18,2	24,6	4,25	
850 160	16	48	20,8	32	5,25	

Stap 3.5 x d Norm NFE 26012

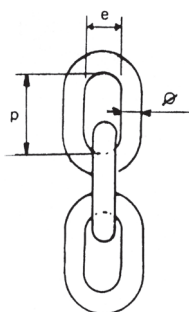

Ref.	Diam. ketting (mm)	Buiten afmetingen (mm)		Breukkracht (t)	Gewicht (kg/m)	Code art.
		p	e mini			
860 080	8	28	11,2	8	1,31	
860 100	10	35	14	12,5	2,05	
860 120	12	42	16,8	18	2,96	
860 140	14	49	19,6	24,6	4,02	
860 160	16	56	22,4	32	5,26	



Totale oppervlakte 3000m² (gebouw : 1100m², werkplaats : 900m², burelen : 200m²) - Ruime parking

NV INDUSTRIAL LIFTING SA

**OUDSTRIJDERSSTRAAT, 31
B-1600 SINT-PIETERS-LEEUEW (BELGIUM)**

Tel.: +32 (0)2 378 06 50 (4L) Fax.: +32 (0)2 377 58 91

Website : www.ilsa.be E-mail : ilsa@skynet.be

